

# DISTRICT PUBLIC SCHOOL & COLLEGE DEPALPUR

## Winter Task Home Assignments

(Academic Session 2020-21)

Class: Prep



Student Name: \_\_\_\_\_

Father Name: \_\_\_\_\_

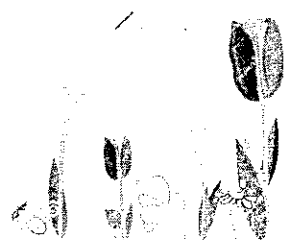
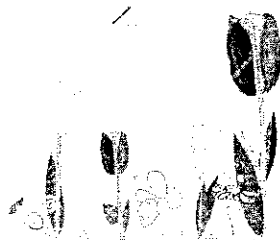
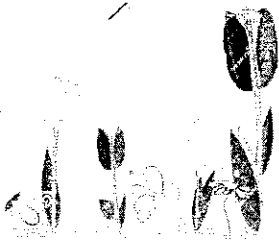
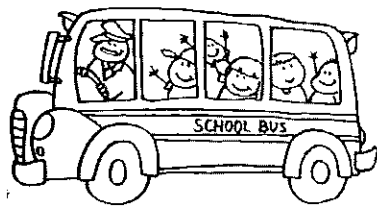
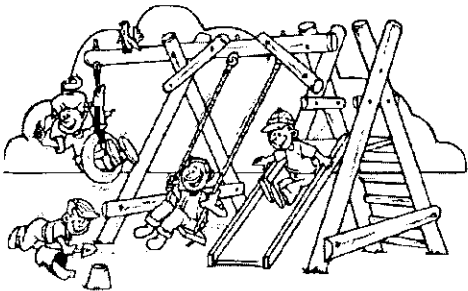

## WINTER TASK

### Home Assignment and Worksheet 2020-21

#### Message to parents:

Dear parents,

Please help and guide your child doing these assignments.

- Let your child follow the given writing pattern.
- Assignments must be done regularly.
- Make sure that the child should use sharpened pencil and avoids the excessive use of eraser.
- Make sure that your child can read what he/she writes.
- Make sure that you child has learnt that concept he/she is reading or writing.
- Parents are the primary source of Tarbiyah religious and cultural values development in their war / children and are also responsible to support their children in developing positive behaviors and values.
- To make your children responsible society members, model and teach them moral values like honesty, loyalty, respect, self – reliance self – discipline, patience, kindness, gratitude forgiveness, personal responsibility and courtesy. As parents, you need to practice what you preach / teach.
- Habits becomes second nature through regular practice. The habits learnt in early years will stay with them for the rest of their lives.
- Adopt a positive mind – set yourself and make sure the environment at home is happy and comfortable.

**Stay Home, Stay Save**

Principal  
DPS & College Depalpur



# DISTRICT PUBLIC SCHOOL & COLLEGE DEPALPUR

## Block Syllabus Session 2020-21

Class: Prep

Subject	2 <sup>nd</sup> Semester 9 <sup>th</sup> November, 2020 to 30 <sup>th</sup> January, 2021
English New oxford Modern English Primer B and Work book B By Nicholas Horsburgh	<ul style="list-style-type: none"><li>• Book reading page:21-50</li><li>• Work book page:31-69</li><li>• Dictation words (box, man, tree, book, bird, city, hen, cat, bat, pen)</li><li>• Actions words (running, eating, drinking, reading, sleeping)</li><li>• Name of fruits (apple, banana, grapes, pear, orange,) (any five)</li><li>• Name of vegetables (onion, potato, peas, carrot, tomato)(any five)</li><li>• Words sentences (rice, face, bird, cake, ring)</li><li>• Question Answers (concept)</li><li>• (Creative writing) My self</li></ul>
Conversation Reffered by teacher	<ul style="list-style-type: none"><li>☆ My School</li><li>☆ My School Staff</li><li>☆ My class room</li></ul>
English Rhymes Reffered by Teacher	<ul style="list-style-type: none"><li>☆ Clean white teeth</li><li>☆ Number song</li><li>☆ Rain Rain go Away</li><li>☆ Two little dicky birds</li><li>☆ Wheel on the bus.</li></ul>
اردو چنبیلی اردو کا گلدستہ نظر ثانی شدہ (فوزیہ احسان فاروقی)	چنبیلی صفحہ نمبر 59 تا 116 پڑھائی صفحہ نمبر (65,73,74,76,86,87,94,99,100,112) الفاظ، جملے (5) روٹی، ٹافی، موتی، گاڑی، سوتی پرندوں کے نام (5) کوا، کبوتر، طوطا، مور، چڑیا تخلیقی لکھائی: میرا تعارف خالی جگہ (65,68,70,116) املا کے الفاظ (مانو، گول، باغ، نوٹ، بوٹی، نرم، دانے، کوٹ، امی، گڑیا) حروف الگ کریں۔ صفحہ نمبر 84، 85 لفظ بنائیے۔ صفحہ نمبر 91، 114، 71 ملائیے صفحہ نمبر 103، 102، 101، 97، 96، 83، 82، 81، 77 پڑھیے اور لکھیے۔ 88، 89، 90، 107، 110، 111

<p>تارے "ریڈر" (فوزیہ احسان فاروقی)</p>	<p>صفحہ نمبر۔ 24 تا 52 پیارامور، چور کون، ٹوپی، کوٹی، زارا کی روٹی، میری بات مانو، تارے، علی کے چوزے، پکڑم پکڑائی، رنگ اور پھول، مانو بے چاری۔</p>
<p>اردو نظمیں Reffered by Teacher</p>	<p>مچھلی کا شکار مرغی اور چڑیا بچے اور پھول</p>
<p>Mathematics New Count Down Second Edition Primer B By Oxford University Press</p>	<ul style="list-style-type: none"> <li>• Book page (36,37,38,39,40,50,64,66,68,72,73,74,)</li> <li>• Counting in numbers (101-150)</li> <li>• Concepts: (Dodging number, missing numbers, what comes before ,after, between ,bigger smaller numbers,)</li> <li>• Counting in words (11-20)</li> <li>• Missing numbers (50-100)</li> <li>• Dodging numbers (1-50)</li> <li>• Bigger and smaller numbers</li> <li>• Flat Shapes: circle, square, triangle, oval, rectangle</li> <li>• Subtraction and Addition</li> <li>• Even and Odd numbers</li> <li>• Ascending And Descending order</li> <li>• Mental Maths ( Table of 3, what comes after+ between+ before)</li> </ul>
<p>Science Book and work book The science Factor for primary classes starter by Nicolas Brasch</p>	<p>Book and work book Unit#05" Water" Unit#06" Force" Unit#07" Heat and light" Unit#08" sounds" Unit#09" The solar system" (Question/Answer) ,True/false, matching, labelling, Fill in the blanks(5)</p>
<p>Manners Reffered by Teacher on knowledge treasure</p>	<p>Manners of classroom &amp; corridoor Manners of health and hygeine Manners of table and eating Manners of School Respect your parents, Respect your Teachers</p> <p>کھانا کھانے کے آداب، پانی پینے کے آداب</p>
<p>Art work &amp; Drawing Book Wise "C"</p>	<ul style="list-style-type: none"> <li>☆ Book Page: 17-32</li> <li>☆ Sponge printing</li> <li>☆ Paper origami</li> <li>☆ Fluffy duck</li> <li>☆ Little boat</li> <li>☆ Decorate your dino</li> <li>☆ Thumb printing</li> <li>☆ Collage House</li> </ul>

	<ul style="list-style-type: none"> <li>☆ Dumbo, the elephant</li> <li>☆ Sunrise</li> </ul>
<b>Social Study</b>	<ul style="list-style-type: none"> <li>☆ Book Page 18-39</li> <li>☆ Our lives</li> <li>☆ Plants and animals</li> <li>☆ About Pakistan</li> <li>☆ Earth &amp; Sky</li> </ul>
اسلامیات Referred by Teacher	تیسرا کلمہ ، سورۃ الکوثر ، سورت الناس ، اللہ تعالیٰ کے صفاتی نام (5) عنوان ہمارا پیارا نبی ﷺ ، عنوان روزہ ، عنوان حج ، دعا کیں ۔
<b>G. Knowledge</b> Referred by teacher	Animals, , Clothes, Seasons, Solar System ,Senses, , Name of colours.
<b>Theme of weeks</b> (Conversation & General Knowledge) Referred by (My Knowledge Treasure-2)	<p><b>Transport:</b> Q#1 Tell the name of transport? Q#2 Tell the types of transport? Q#3 Tell the name of land transport? Q#4 Tell the name water transport? Q#5 Tell the name of air transport? Q#6 Tell the medium of transport that you use of school? <b>Safety:</b> Q#1 Can children use dangerous things? Q#2 Can you play with match box? Q#2 Tell the rules to cross the road? Q#3 Can you take anything from strangers? Q#4 Can you go anywhere with strangers? <b>Sports:</b> Q#1 Tell the name of sports thing? Q#2 Which is your favorite game? Q#3 Tell the name indoor games? Q#4 Tell the name of outdoor games? <b>Allama Iqbal:</b> Q#1 Who is our national poet? Q#2 When Allama Iqbal was born? Q#3 Where Allama Iqbal was born? Q#4 Who gave the idea of Pakistan? <b>Animals:</b> Q#1 Tell the name of animals? Q#2 Tell the kinds of animals? Q#3 Tell the name of farm animals? Q#4 Tell the name of sea animals? Q#5 Tell the name of wild animals? Q#6 What we got from animals? Q#7 Who have visited the zoo? <b>Autumn Season:</b> Q#1 What will the colour of plants in autumn? Q#2 Do you like plantations? Q#3 Do you like leaves collections? Q#4 Do you like autumn seasons? <b>Winter Season:</b> Q#1 How's the weather in winter? Q#2 Which type of clothes do your wear in winter? Q#3 Which fruits are available in winter? Q#4 Do you like winter season? <b>Community Services:</b> Q#1 Who community helpers/servants? Q#2 What do you like to be? Q#3 What is your father's professions? Q# 4 Helping other is good/bad?</p>

Coordinator: Nazim Zaidi Section Head: M. J. J. Principal: \_\_\_\_\_  
Dated: 10<sup>th</sup> November, 2020 Dated: 10<sup>th</sup> November, 2020 Dated: \_\_\_\_\_

# Contents

- English Pg. 1 to 25
- Mathematics Pg. 26 to 52
- Science Pg. 53 to 75
- Urdu Pg. 76 to 101

Mother/Father's sign: \_\_\_\_\_

# Subject English

## Winter Task Home Assignments

(Academic Session 2020-21)

Class: Prep

Student Name: \_\_\_\_\_

Father Name: \_\_\_\_\_



**WRITE THE WORDS.**



t \_\_\_\_\_



w \_\_\_\_\_



t \_\_\_\_\_

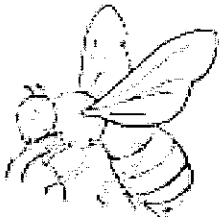

b \_\_\_\_\_

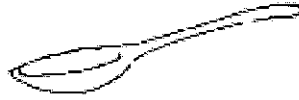

s \_\_\_\_\_



l \_\_\_\_\_

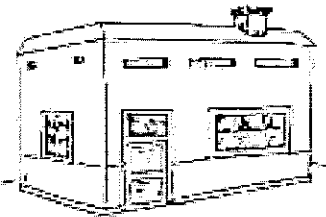

h \_\_\_\_\_



c \_\_\_\_\_



f \_\_\_\_\_



m \_\_\_\_\_

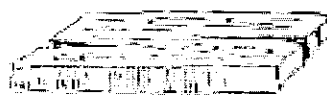

w \_\_\_\_\_

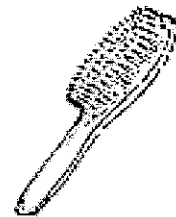

b \_\_\_\_\_

Father's /Mother's sign \_\_\_\_\_



Date: 27<sup>th</sup> November, 2020

Day: Friday

## TALK ABOUT THE PICTURES.

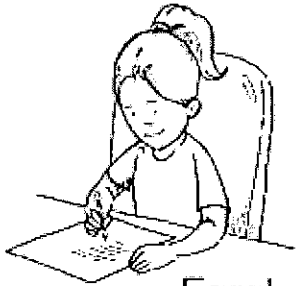

Farah



Nadia

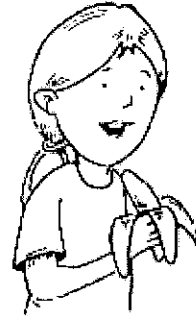

Lubna

## ANSWER THE QUESTIONS.

1. Who is eating a banana?

\_\_\_\_\_.

2. Who is writing?

\_\_\_\_\_.

3. Who is drinking water?

\_\_\_\_\_.

Father's / Mother's sign \_\_\_\_\_

**WRITE THE WORDS.THEY ARE VERBS.**

①	s	t			d				
		②	d		a				
		③	r			n			
		④	d	a	n	c	i	n	g
			⑤	w		i			
⑥	s					n			
⑦	e					g			

**WRITE THE NUMBERS.**

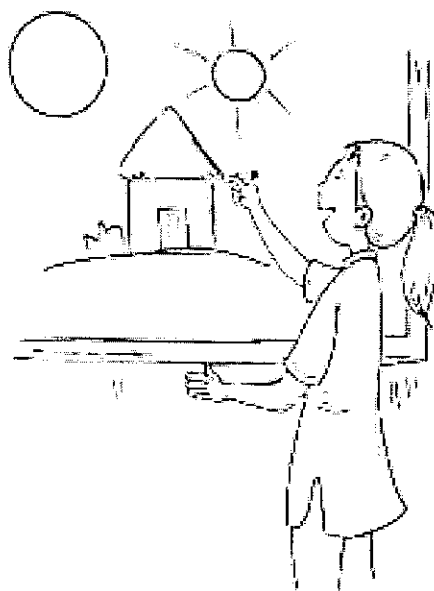
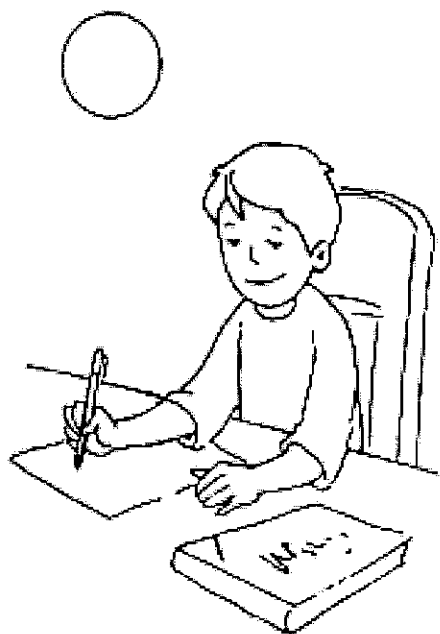

Father's /Mother's sign \_\_\_\_\_

Date: 30<sup>th</sup> November, 2020

Day : Monday

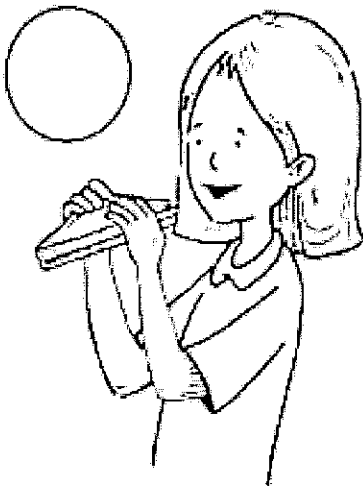
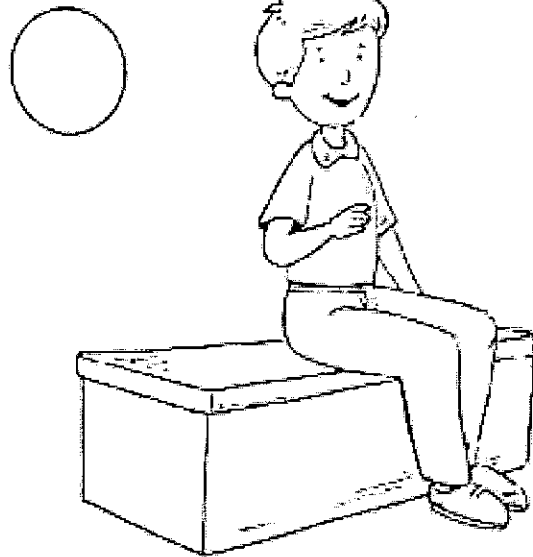
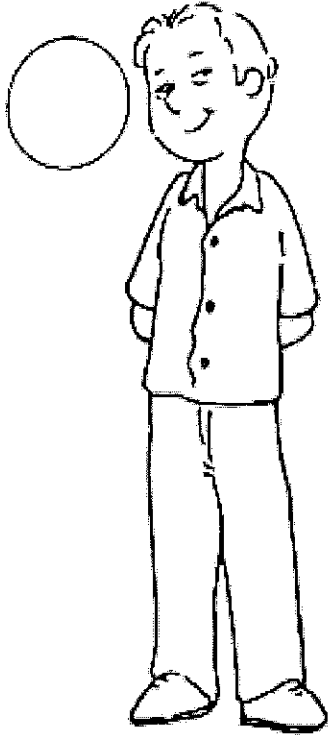

Father's /Mother's sign \_\_\_\_\_

Date: 1<sup>st</sup> December, 2020

Day: Tuesday

# COLOR THE PICTURES.

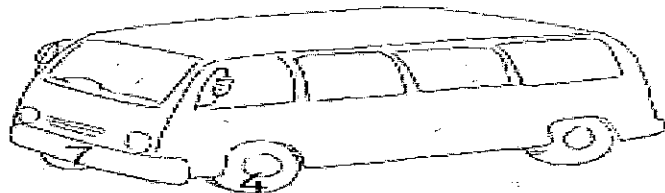
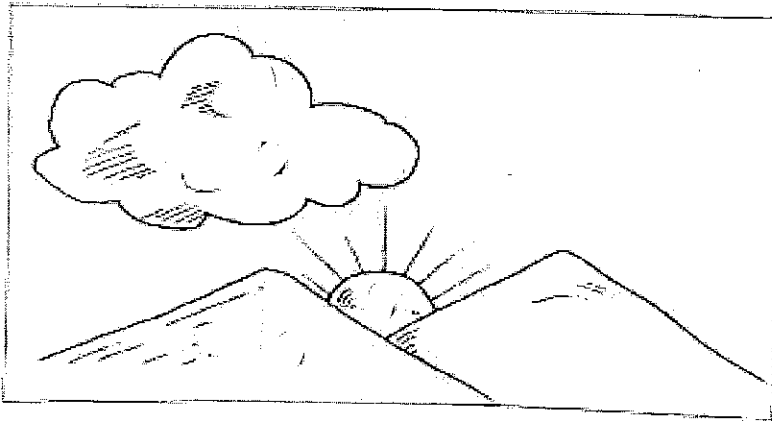
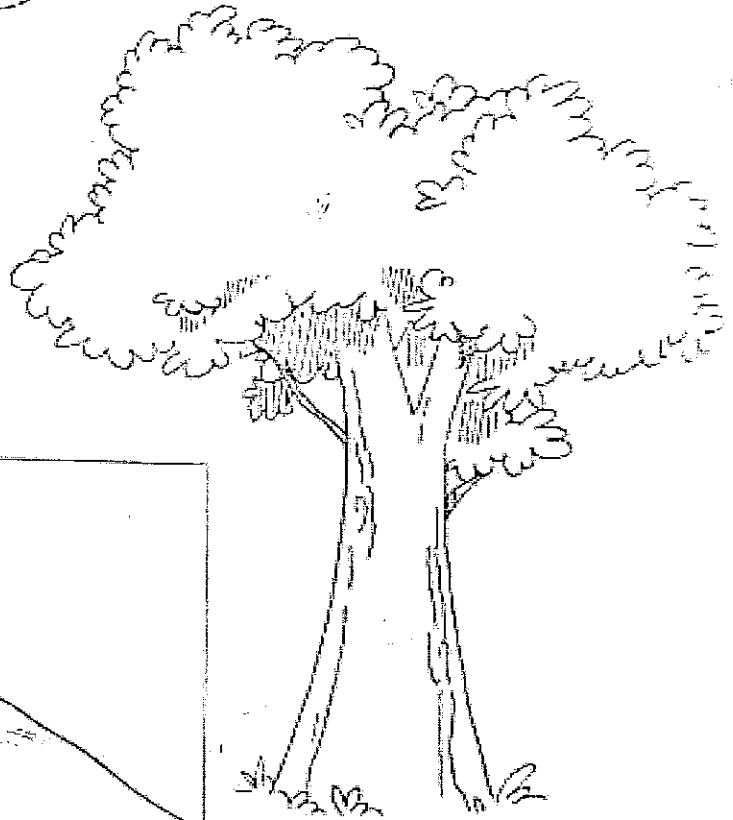
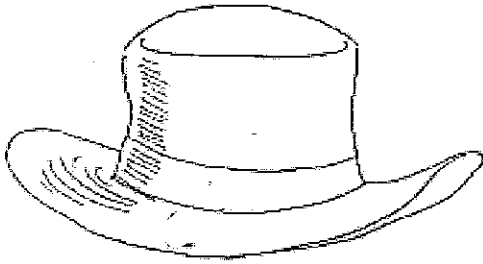
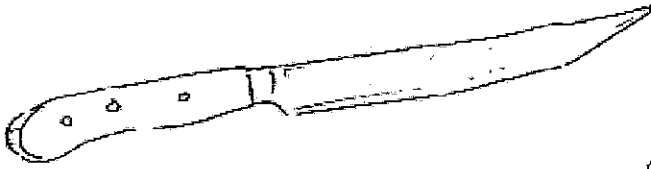

Father's /Mother's sign \_\_\_\_\_

Date: 2nd December, 2020

Day : Wednesday

**WRITE SENTENCES LIKE THESE:**

This is a dog.



Its nose is black.

This is a d \_\_\_\_\_



Its tail is \_\_\_\_\_

duck/tail/short

\_\_\_\_\_

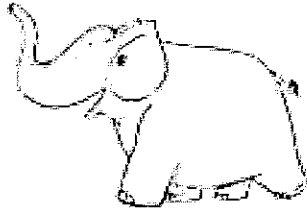

\_\_\_\_\_

elephant/legs/thick

\_\_\_\_\_



\_\_\_\_\_

hut/roof/old

\_\_\_\_\_



\_\_\_\_\_

cow/horns/long

Father's /Mother's sign \_\_\_\_\_

# WRITE THE NUMBERS AND NAMES.

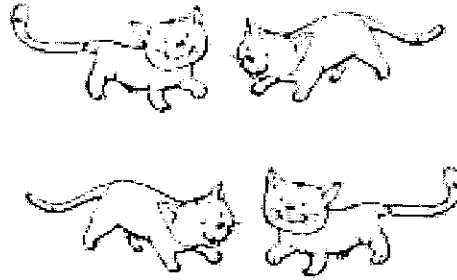
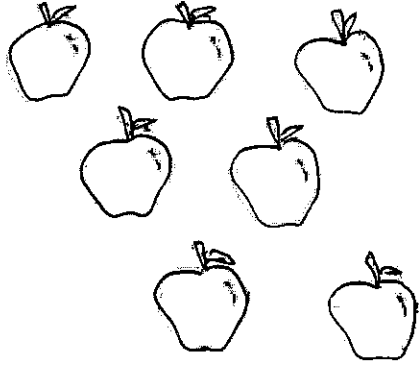

Seven apples

---

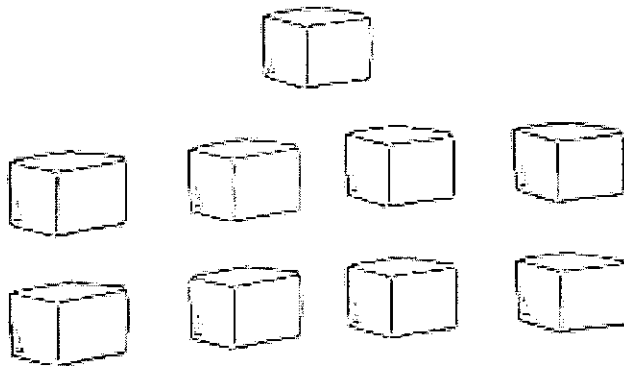
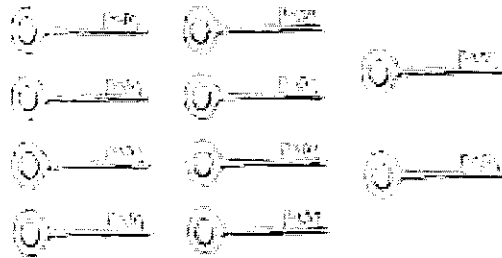
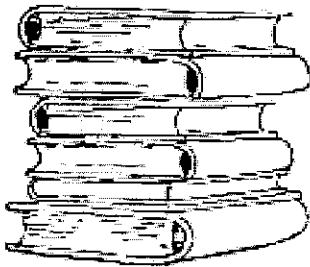

Father's /Mother's sign \_\_\_\_\_

### TALK ABOUT THE PICTURES.



Ruby

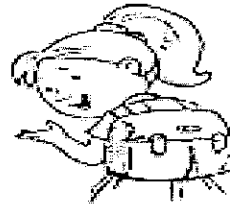

Jane



Bob



Peter

### WRITE SENTENCES

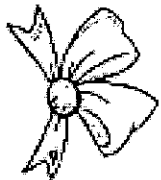

This is Ruby's \_\_\_\_\_

ribbon                      hat



This is \_\_\_\_\_

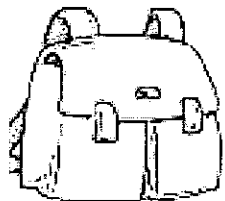

\_\_\_\_\_

bag                              pencil

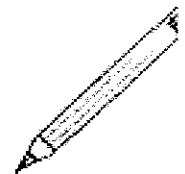

Father's /Mother's sign \_\_\_\_\_

**WRITE QUESTIONS FOR THE ANSWERS.**

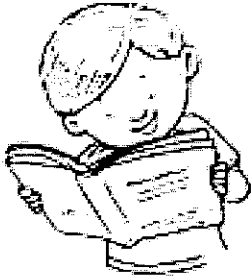

What is the boy doing?  
He is reading a book.



W \_\_\_\_\_?  
He is washing his face.

\_\_\_\_\_?  
It is flying.



\_\_\_\_\_?  
They are playing.

\_\_\_\_\_?  
They are running.

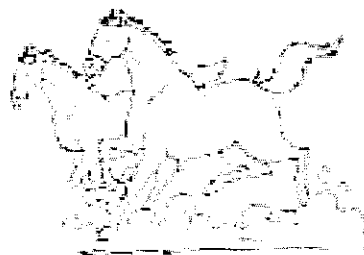

Father's /Mother's sign \_\_\_\_\_



**WRITE QUESTIONS.**

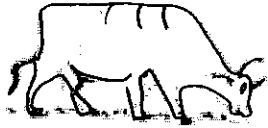

Is this a goat?

No, it is not.

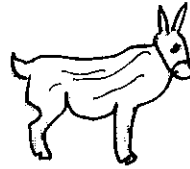

Is \_\_\_\_\_ ?

Yes, it is.



\_\_\_\_\_ ?

No, it is not.

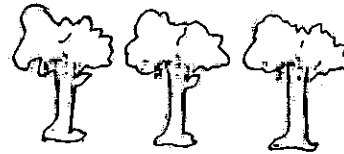

Are \_\_\_\_\_ ?

Yes, they are.

**WRITE ANSWERS.**



Is this an egg?

\_\_\_\_\_



Is this a cot?

\_\_\_\_\_

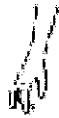

Is this a foot?

\_\_\_\_\_

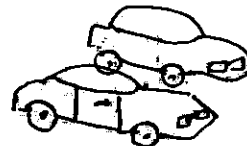

Are these cars?

\_\_\_\_\_

Father's /Mother's sign \_\_\_\_\_

# Their

WRITE SENTENCES LIKE THESE.

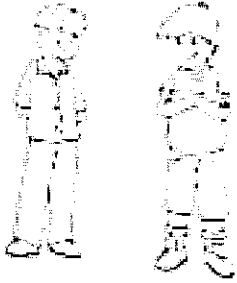

These are boys.  
These are their books.

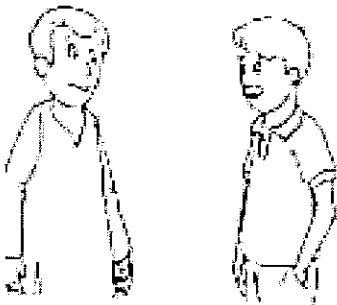
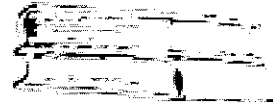

These are m\_\_\_\_\_.  
These are their \_\_\_\_\_.

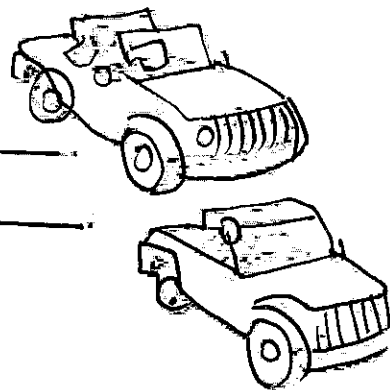

These \_\_\_\_\_  
\_\_\_\_\_

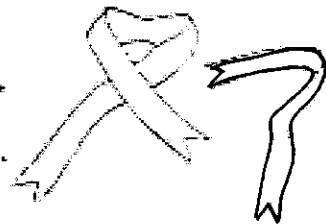

Father's /Mother's sign \_\_\_\_\_

# Look and say



Count the animals. Then write sentences like this:

- goats
- birds
- owl
- rabbits
- cows
- ducks
- horses

Two goats are running.  
Eight b \_\_\_\_\_  
\_\_\_\_\_  
\_\_\_\_\_  
\_\_\_\_\_  
\_\_\_\_\_

- eating
- sleeping
- running
- jumping
- flying
- walking
- swimming

Father's /Mother's sign \_\_\_\_\_

# Time

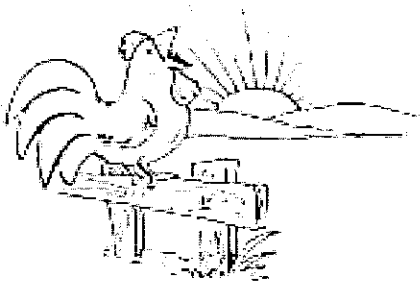

morning

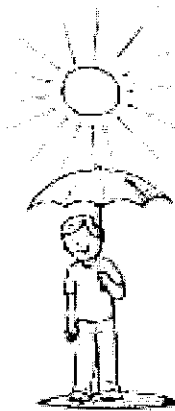

afternoon



evening

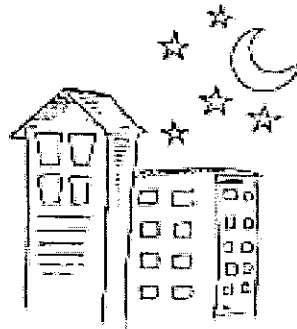

night

## RIGHT OR WRONG?

Mark the sentences ✓ or ✗.

I eat breakfast in the morning.

I eat lunch in the evening.

I eat dinner in the morning.

I eat breakfast in the afternoon.

I eat dinner in the evening.

I eat lunch in the afternoon.

Father's /Mother's sign \_\_\_\_\_

Date: 11<sup>th</sup> December, 2020

Day: Friday

## Dictation words

<b>box</b>				
<b>man</b>				
<b>tree</b>				
<b>book</b>				
<b>bird</b>				
<b>city</b>				
<b>hen</b>				
<b>cat</b>				
<b>bat</b>				
<b>pen</b>				

Father's /Mother's sign \_\_\_\_\_

Date: 12<sup>th</sup> December, 2020

Day: Saturday

## Dictation words

<b>box</b>				
<b>man</b>				
<b>tree</b>				
<b>book</b>				
<b>bird</b>				
<b>city</b>				
<b>hen</b>				
<b>cat</b>				
<b>bat</b>				
<b>pen</b>				

Father's /Mother's sign \_\_\_\_\_

Date: 14<sup>th</sup> December, 2020

Day: Monday

**Topic: Words Sentences**

Words	Sentences
rice	I like rice.
face	This is a happy face.
bird	Birds can fly.
cake	I like cake.
ring	This is my ring.

**Topic: Words Sentences**

Words	Sentences
rice	
face	
bird	
cake	
ring	

Father's /Mother's sign \_\_\_\_\_

### Topic: Name of Fruits

Words	Write it
Apple	
Banana	
Grapes	
Pear	
orange	

### Topic: Name of Vegetables

Words	Write it
Onion	
Potato	
Peas	
Carrot	
tomato	

Father's /Mother's sign \_\_\_\_\_



### Topic: Action Words

Words	Write it
running	
eating	
drinking	
reading	
sleeping	

### Topic: Action Words

Words	Write it
running	
eating	
drinking	
reading	
sleeping	

Father's /Mother's sign \_\_\_\_\_

Date: 17<sup>th</sup> December, 2020

Day: Thursday

### Topic: Words Sentences

Words	Sentences
rice	I like rice.
face	This is a happy face.
bird	Birds can fly.
cake	I like cake.
ring	This is my ring.

### Topic: Words Sentences

Words	Sentences
rice	
face	
bird	
cake	
ring	

Father's /Mother's sign \_\_\_\_\_

### Topic: Name of Fruits

Words	Write it
apple	
banana	
grapes	
pear	
orange	

### Topic: Name of Vegetables

Words	Write it
onion	
potato	
peas	
carrot	
tomato	

Father's /Mother's sign \_\_\_\_\_

Date: 19<sup>th</sup> December, 2020

Day: Saturday

## Topic: My Self (Creative writing)

name

old

like

red

school

1. My name is Ali.

---

2. I am a six years old.

---

3. I read in class prep.

---

4. I like red color.

---

5. My school name is District Public School and College  
Depalpur.

---

Father's /Mother's sign \_\_\_\_\_



Date: 22<sup>nd</sup> December, 2020

Day: Tuesday

**Topic: Words Sentences**

Words	Sentences
rice	I like rice.
face	This is a happy face.
bird	Birds can fly.
cake	I like cake.
ring	This is my ring.

**Topic: Words Sentences**

Words	Sentences
rice	
face	
bird	
cake	
ring	

Father's /Mother's sign \_\_\_\_\_

Date: 23<sup>rd</sup> December, 2020

Day: Wednesday

## Topic: Name of Fruits

Words	Write it
apple	
banana	
grapes	
pear	
orange	

## Topic: Name of Vegetables

Words	Write it
onion	
potato	
peas	
carrot	
tomato	

Father's /Mother's sign \_\_\_\_\_





# DISTRICT PUBLIC SCHOOL & COLLEGE DEPALPUR

## Winter Task, Home Assignments

(Academic Session 2020-21)



Class: PREP

Student Name: \_\_\_\_\_

Father Name: \_\_\_\_\_



Mother/Father's sign: \_\_\_\_\_

# Subject Mathematics

## Winter Task, Home Assignments

(Academic Session 2020-21)

Class: PREP

Student Name: \_\_\_\_\_

Father Name: \_\_\_\_\_

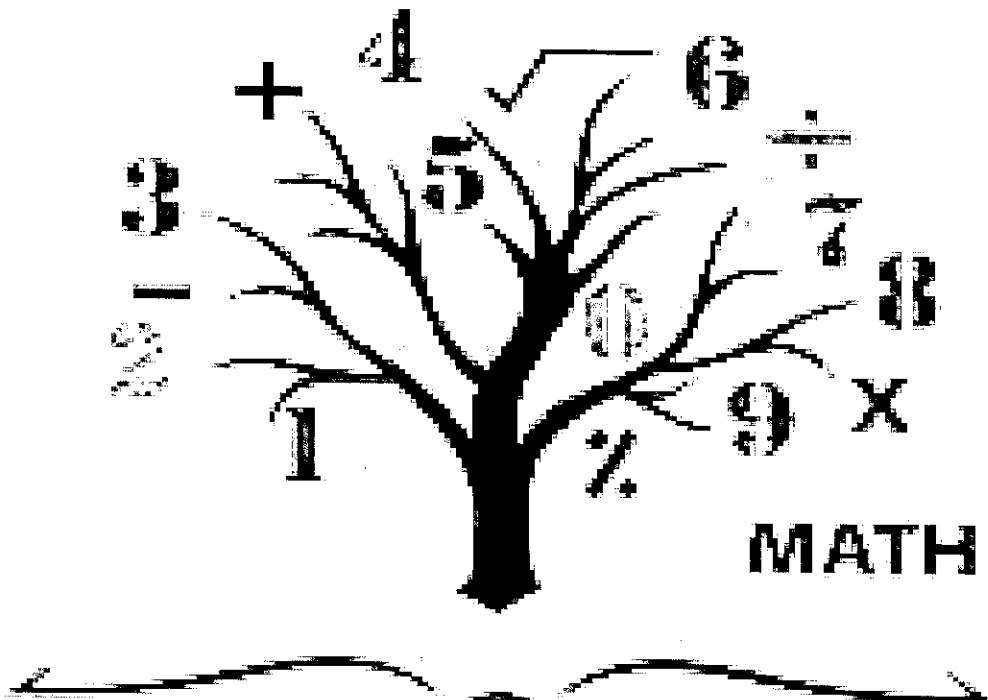

Mother/Father's sign: \_\_\_\_\_





**Missing Numbers****51 to 100****Fill in the Missing numbers.**

51				55				59	
	62				66				70
		73				77			
	82			85					90
91					96				100

**Fill in the Missing numbers 51 to 100.**

51				55				59	
	62				66				70
		73				77			
	82			85					90
91					96				100

Mother/Father's sign: \_\_\_\_\_

Day: 30<sup>th</sup> November, 2020

Date: Monday

### Addition:

Add the following.

5	+	3	=	8
7	+	2	=	
6	+	0	=	
3	+	3	=	
2	+	6	=	
2	+	5	=	
0	+	1	=	

### Color the Shape

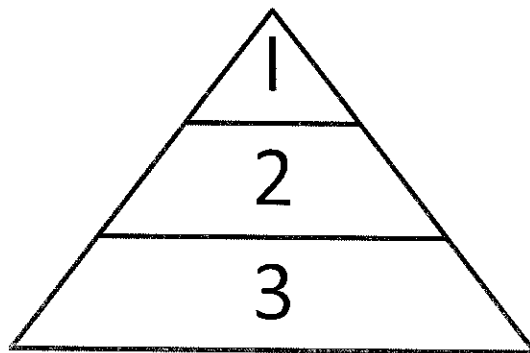

Mother/Father's sign: \_\_\_\_\_

# Counting in Words eleven to twenty.

11

--	--	--	--	--	--	--

12

--	--	--	--	--	--	--

13

--	--	--	--	--	--	--	--

14

--	--	--	--	--	--	--	--

15

--	--	--	--	--	--	--	--

16

--	--	--	--	--	--	--	--

17

--	--	--	--	--	--	--	--	--

18

--	--	--	--	--	--	--	--

19

--	--	--	--	--	--	--	--

20

--	--	--	--	--	--	--

Mother/Father's sign: \_\_\_\_\_

Date: 2nd December, 2020

Day: Wednesday

## Backward Counting 30-1

Count backwards from 30 to 1 and write in the box.

30	20	10
21	11	1

Mother/Father's sign: \_\_\_\_\_



**Write the numbers that come before and after.**

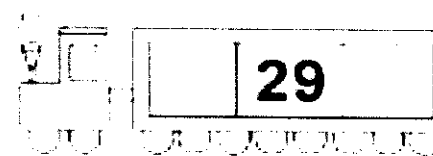
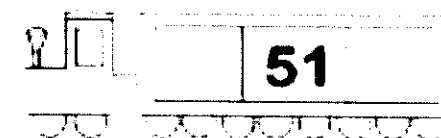
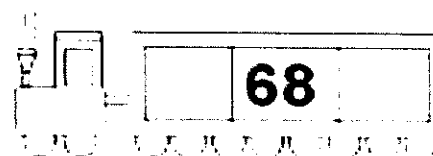
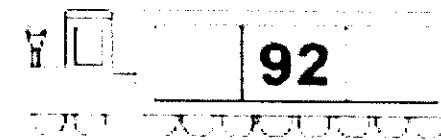
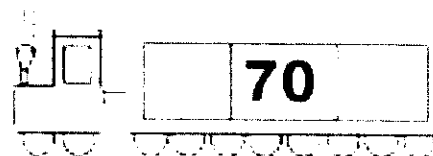
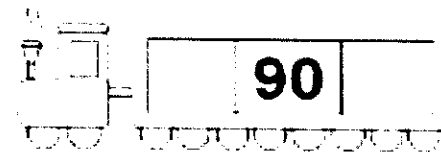
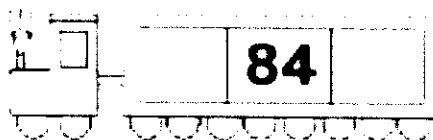
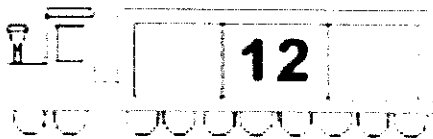
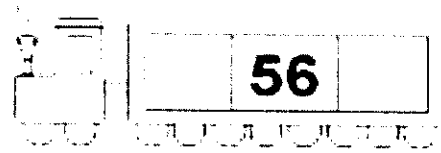
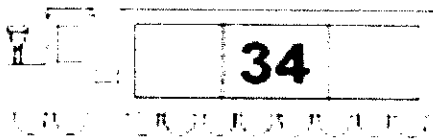

Mother/Father's sign: \_\_\_\_\_

Date: 4<sup>th</sup> December, 2020

Day: Friday

## Color the shapes

Color the shapes as per the defined colors.

red

yellow

blue

green

circle

square

triangle

rectangle

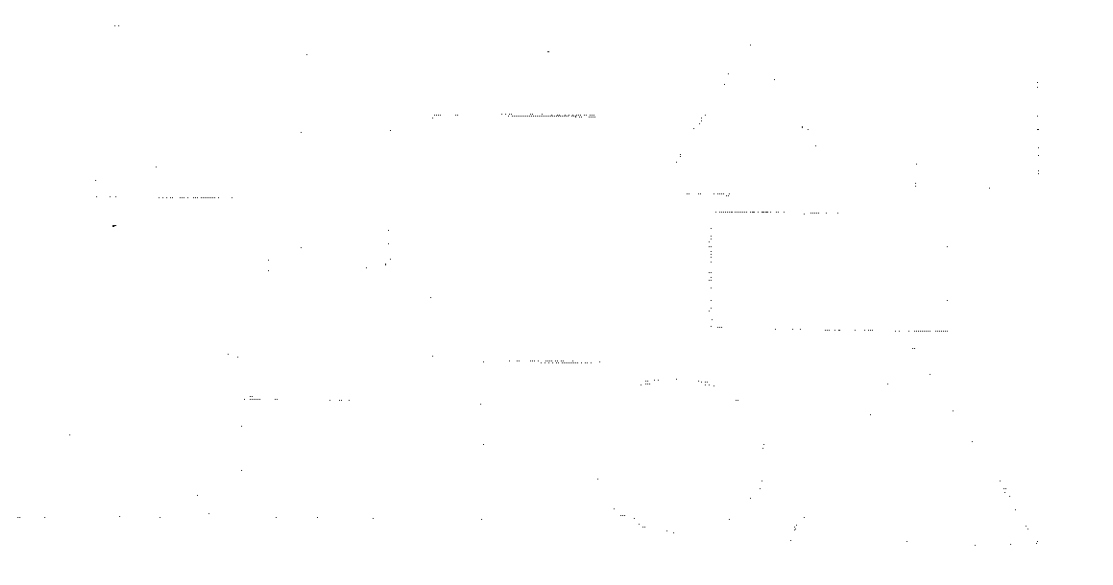

Color the picture using the correct color for each shape.

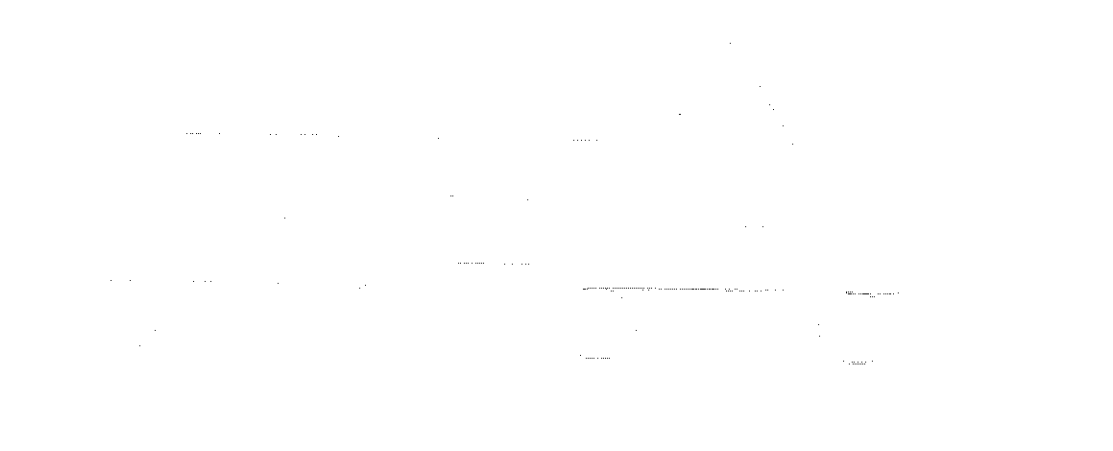

Mother/Father's sign: \_\_\_\_\_

Date: 5<sup>th</sup> December, 2020

Day: Saturday

**Before, after, and between =**

**Fill in the numbers that comes...**

**...before**

**...after**

**...between**

17 18

11 12

15 16 17

15

14

10 12

9

17

13 15

19

9

19 17

12

12

16 14

16

8

13 11

20

10

20 18

**Tick (v) the biggest number and circle the smallest number. One has been done it.**

18 11 14 10 9 12 13 10

15 11 20 19 16 18 17 19

7 6 0 8 13 16 14 11

Mother/Father's sign: \_\_\_\_\_

**Addition:**

**Add the following.**

$1 + \quad = 10$

$2 + \quad = 10$

$2 + \quad = 10$

$7 + \quad = 10$

$3 + \quad = 10$

$6 + \quad = 10$

$4 + \quad = 10$

$5 + \quad = 10$

$5 + \quad = 10$

$9 + \quad = 10$

$6 + \quad = 10$

$4 + \quad = 10$

$7 + \quad = 10$

$3 + \quad = 10$

$8 + \quad = 10$

$8 + \quad = 10$

$9 + \quad = 10$

$1 + \quad = 10$

Mother/Father's sign: \_\_\_\_\_

### Making 10

Count the dots and write in the box.



$$\underline{\quad} 9 + \underline{\quad} 1 = \underline{\quad} 10$$



$$\underline{\quad} 8 + \underline{\quad} = \underline{\quad} 10$$



$$\underline{\quad} + \underline{\quad} = \underline{\quad}$$



$$\underline{\quad} + \underline{\quad} = \underline{\quad}$$



$$\underline{\quad} + \underline{\quad} = \underline{\quad}$$



$$\underline{\quad} + \underline{\quad} = \underline{\quad}$$



$$\underline{\quad} + \underline{\quad} = \underline{\quad}$$

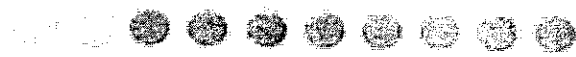

$$\underline{\quad} + \underline{\quad} = \underline{\quad}$$

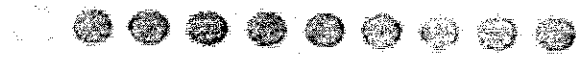

$$\underline{\quad} + \underline{\quad} = \underline{\quad}$$

### Add the following

$$\begin{array}{r} 9 \\ + 1 \\ \hline \end{array}$$

$$\begin{array}{r} 8 \\ + 2 \\ \hline \end{array}$$

$$\begin{array}{r} 5 \\ + 5 \\ \hline \end{array}$$

$$\begin{array}{r} 6 \\ + 4 \\ \hline \end{array}$$

$$\begin{array}{r} 3 \\ + 7 \\ \hline \end{array}$$

Mother/Father's sign: \_\_\_\_\_

## Even and Odd Number

Color blue for the even numbers and color orange for the odd numbers.

2

6

5

8

9

7

3

22

20

35

30

32

25

23

Mother/Father's sign: \_\_\_\_\_

Date: 10<sup>th</sup> December, 2020

Day: Thursday

Tick (✓) the bigger number in each pair. One has been done for **y**ou.

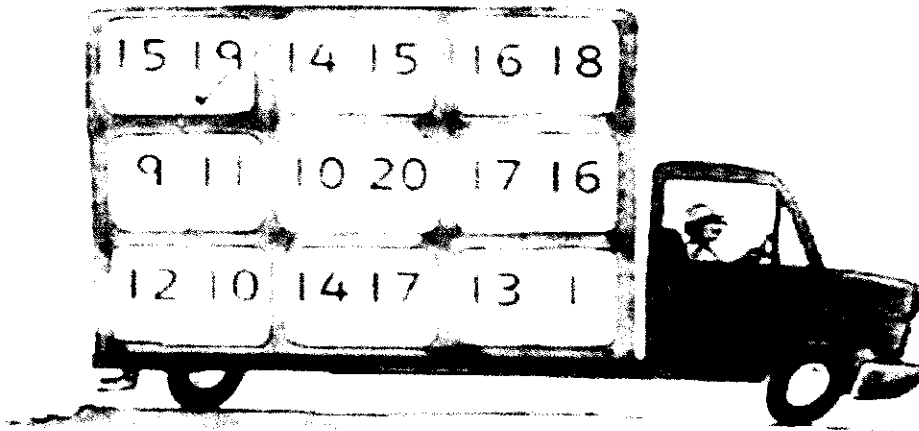

Circle the smaller number in each pair. One has been done for **y**ou.

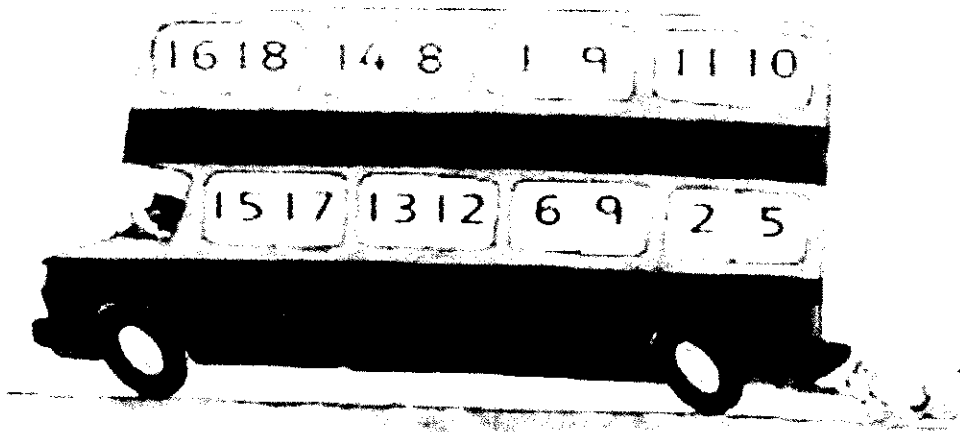

Mother/Father's sign: \_\_\_\_\_

Date: 11<sup>th</sup> December, 2020

Day: Friday

What comes before?

19

20

13

28

25

11

What comes after?

15

17

22

9

29

18

What comes between?

17

19

15

17

9

11

22

24

Write backwards from 20 to 0

20 19

9

1 0

Day: \_\_\_\_\_

Date: \_\_\_\_\_

Mother/Father's sign: \_\_\_\_\_



# Write in descending order

18	5	13
----	---	----

25	15	1
----	----	---

71	17	8
----	----	---

3	5	9
---	---	---

19	25	15
----	----	----

8	28	38
---	----	----

61	36	19
----	----	----

18	13	5
----	----	---

--	--	--

--	--	--

--	--	--

--	--	--

--	--	--

--	--	--

Mother/Father's sign: \_\_\_\_\_

# Calendar

Write the number of days for each month.

January has \_\_\_\_\_ days.

February has \_\_\_\_\_ days.

March has \_\_\_\_\_ days.

April has \_\_\_\_\_ days.

May has \_\_\_\_\_ days.

June has \_\_\_\_\_ days.

July has \_\_\_\_\_ days.

August has \_\_\_\_\_ days.

September has \_\_\_\_\_ days.

October has \_\_\_\_\_ days.

November has \_\_\_\_\_ days.

December has \_\_\_\_\_ days.

---

Mother/Father's sign: \_\_\_\_\_

Do you remember the days of the week?

There are seven days in a week.

- |             |            |
|-------------|------------|
| 1 Monday    | 5 Friday   |
| 2 Tuesday   | 6 Saturday |
| 3 Wednesday | 7 Sunday   |
| 4 Thursday  |            |

Think and write

Which is the first day of the week?

Which day comes after Tuesday?

Which day comes before Friday?

Which is the last day of the week?

Which day comes between Monday and Wednesday?

Mother/Father's sign: \_\_\_\_\_

Date: 16<sup>th</sup> December, 2020

Day: Wednesday

Table of 3

3	X	1	=	3
3	X	2	=	
3	X	3	=	
3	X	4	=	
3	X	5	=	
3	X	6	=	
3	X	7	=	
3	X	8	=	
3	X	9	=	
3	X	10	=	

Mother/Father's sign: \_\_\_\_\_

### Table of 3

3	X	1	=	3
3	X	2	=	
3	X	3	=	
3	X	4	=	
3	X	5	=	
3	X	6	=	
3	X	7	=	
3	X	8	=	
3	X	9	=	
3	X	10	=	

Mother/Father's sign: \_\_\_\_\_

### Addition:

Add the following.

5	+	3	=	8
7	+	2	=	
6	+	0	=	
3	+	3	=	
2	+	6	=	
2	+	5	=	
0	+	1	=	

### Color the Shape

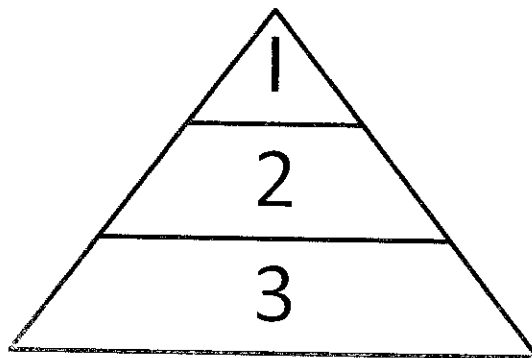

Mother/Father's sign: \_\_\_\_\_

Date: 1

Day: Saturday

# Counting in Words eleven to twenty.

11

--	--	--	--	--	--	--	--

12

--	--	--	--	--	--	--	--

13

--	--	--	--	--	--	--	--	--	--

14

--	--	--	--	--	--	--	--	--	--

15

--	--	--	--	--	--	--	--	--	--

16

--	--	--	--	--	--	--	--	--	--

17

--	--	--	--	--	--	--	--	--	--	--

18

--	--	--	--	--	--	--	--	--	--	--

19

--	--	--	--	--	--	--	--	--	--	--

20

--	--	--	--	--	--	--	--

Mother/Father's sign: \_\_\_\_\_

Write the numbers that come before and after.

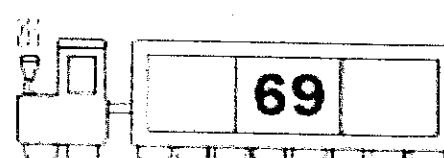
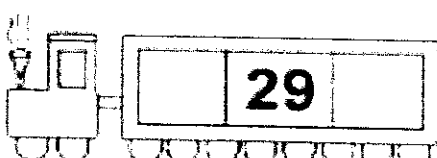
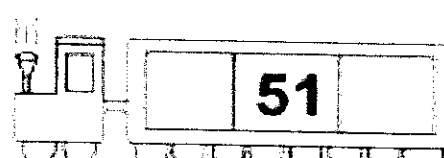
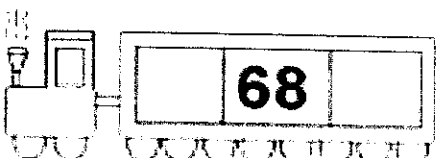
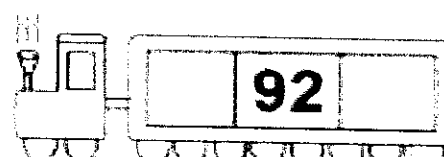
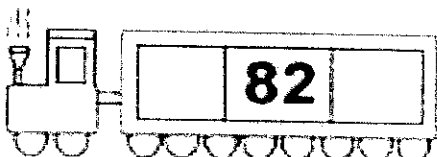
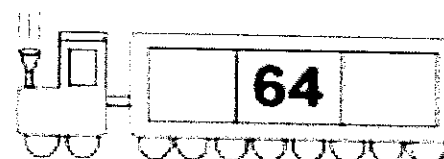
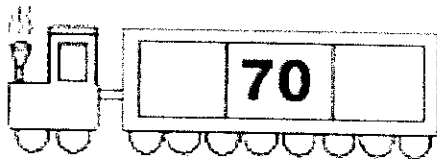
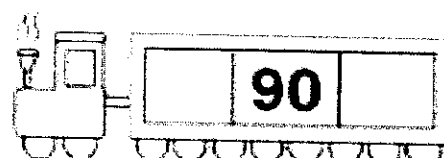
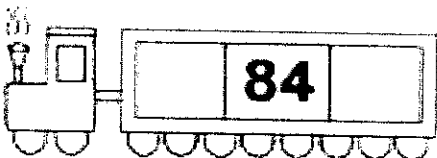
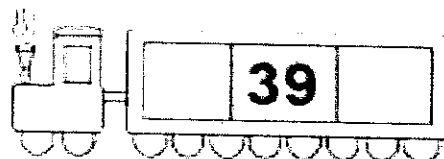
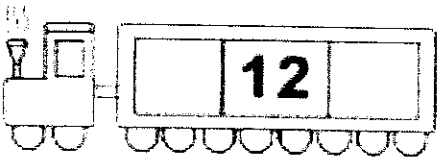
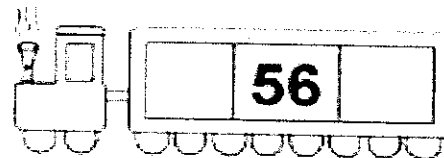
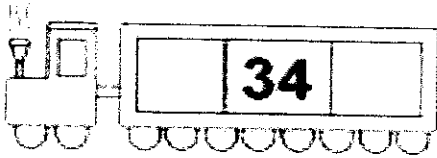

Mother/Father's sign: \_\_\_\_\_



## Even and Odd Number

Color blue for the even numbers and color orange for the odd numbers.

2

6

5

8

9

7

3

22

20

30

32

35

25

23

Mother/Father's sign: \_\_\_\_\_

# Subtraction



$2 - 2 =$

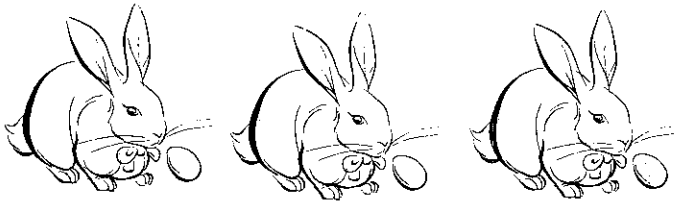

$3 - 1 =$

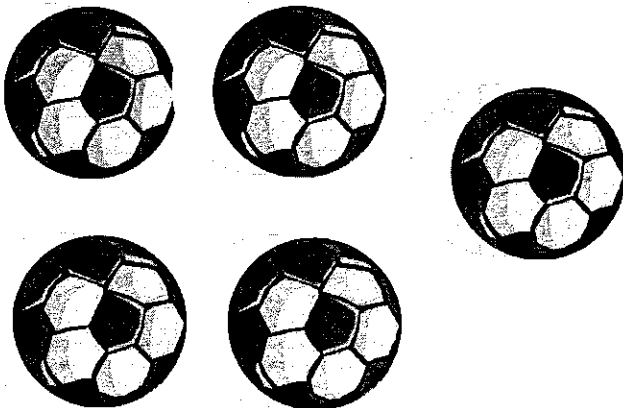









$5 - 3 =$

Mother/Father's sign: \_\_\_\_\_

# Making 10

Count the dots and write in the box.

	<input type="text" value="9"/>	+	<input type="text" value="1"/>	=	<input type="text" value="10"/>
	<input type="text" value="8"/>	+	<input type="text"/>	=	<input type="text" value="10"/>
	<input type="text"/>	+	<input type="text"/>	=	<input type="text"/>
	<input type="text"/>	+	<input type="text"/>	=	<input type="text"/>
	<input type="text"/>	+	<input type="text"/>	=	<input type="text"/>
	<input type="text"/>	+	<input type="text"/>	=	<input type="text"/>
	<input type="text"/>	+	<input type="text"/>	=	<input type="text"/>
	<input type="text"/>	+	<input type="text"/>	=	<input type="text"/>
	<input type="text"/>	+	<input type="text"/>	=	<input type="text"/>

Add the following

$\begin{array}{r} 9 \\ + 1 \\ \hline \end{array}$ <input type="text"/>	$\begin{array}{r} 8 \\ + 2 \\ \hline \end{array}$ <input type="text"/>	$\begin{array}{r} 5 \\ + 5 \\ \hline \end{array}$ <input type="text"/>	$\begin{array}{r} 6 \\ + 4 \\ \hline \end{array}$ <input type="text"/>	$\begin{array}{r} 3 \\ + 7 \\ \hline \end{array}$ <input type="text"/>
--	--	--	--	--

Mother/Father's sign: \_\_\_\_\_

# Winter Task Home Assignments

(Academic Session 2020-21)



**Class: Prep**

**Student Name:** \_\_\_\_\_

**Father Name:** \_\_\_\_\_



# Subject Science

## Winter Task Home Assignments

(Academic Session 2020-21)

Class: Prep

Student Name: \_\_\_\_\_

Father Name: \_\_\_\_\_



Date: 26<sup>th</sup> November, 2020

Day : Thursday

Unit : 5 Water

- . Color the parts that show water blue.
- . Color the parts that show land brown.

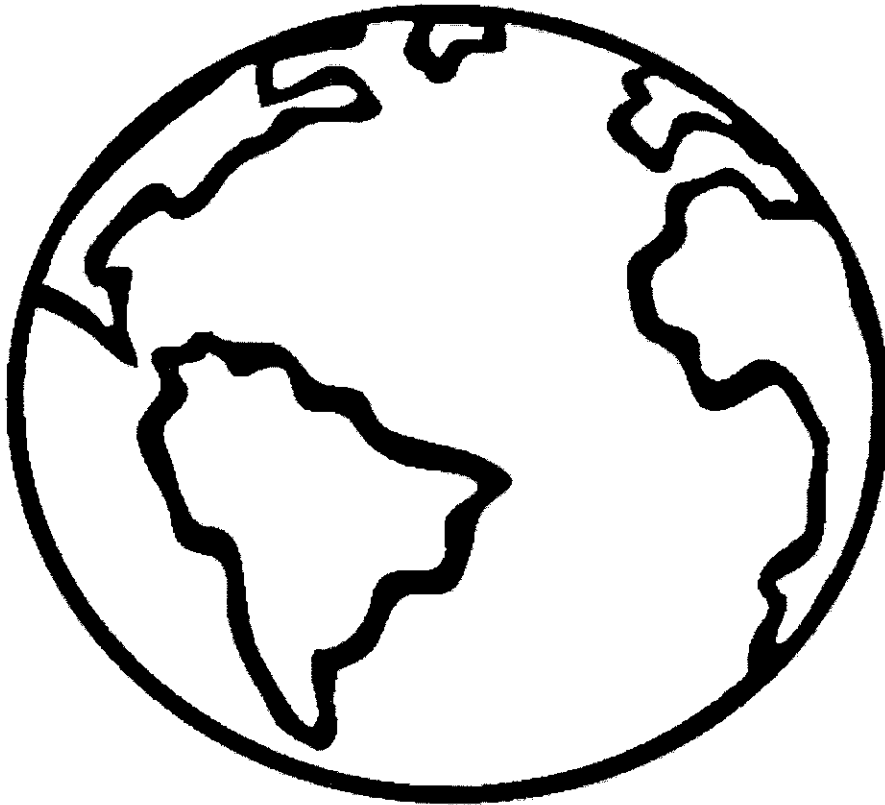

Father's /Mother's sign \_\_\_\_\_

Date: 27<sup>th</sup> November, 2020

Day : Friday

. Circle the living things that need water.

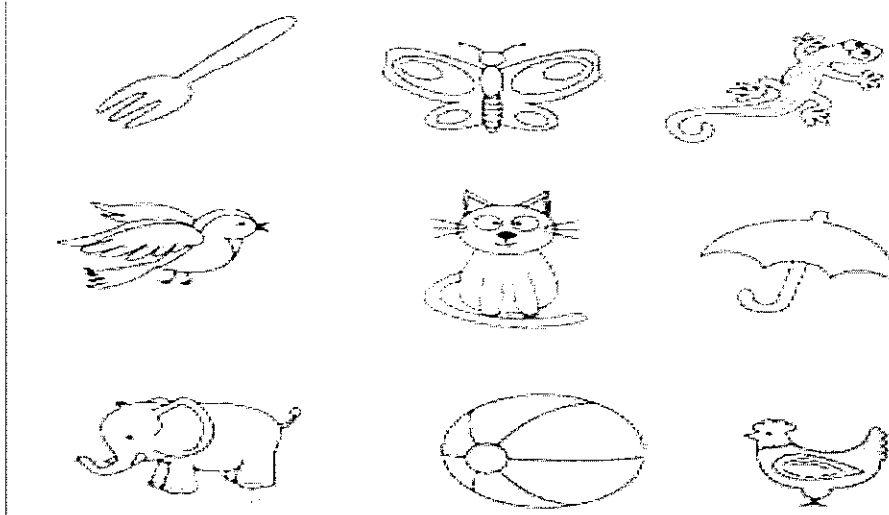

. Color the living things that need water.

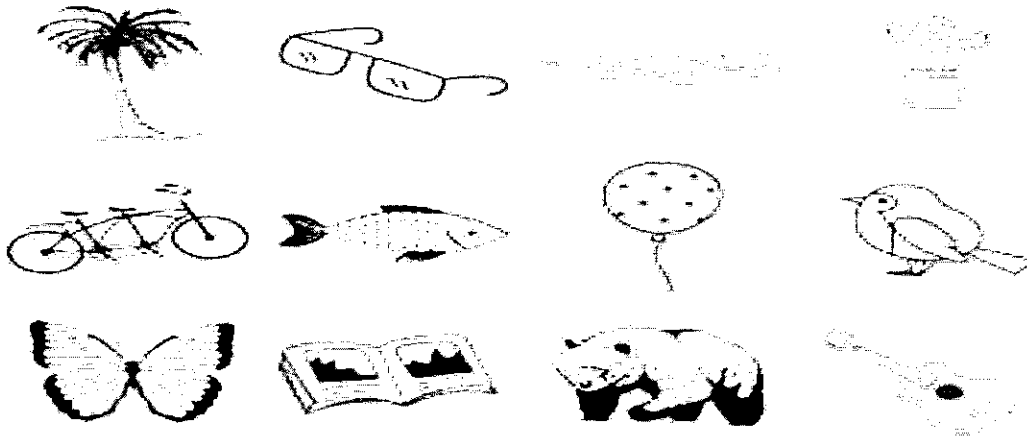

Draw a living thing

Draw a non-living thing.

Father's /Mother's sign \_\_\_\_\_

Date: 28<sup>th</sup> November, 2020

Day : Saturday

. Write the answer yes or not .

Q.1 Do humans need water

---

---

---

Q.2 Do rocks need water

---

---

---

Q . 3 Do plants need water

---

---

---

Q . 4 Do book need water

---

---

---

• Father's /Mother's sign \_\_\_\_\_



Unit : 6 Forces

. Write pull or push ,

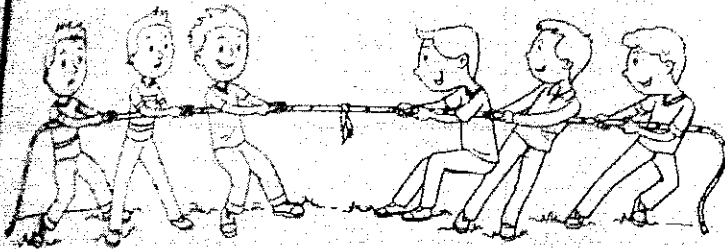

[Empty box for writing]



[Empty box for writing]

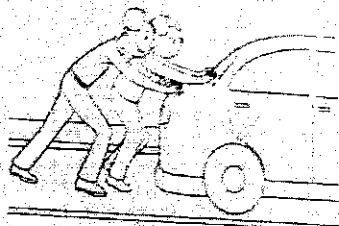

[Empty box for writing]



[Empty box for writing]

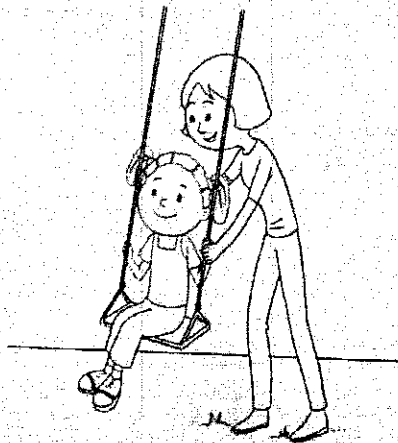

[Empty box for writing]

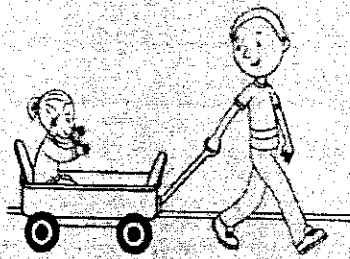

[Empty box for writing]

Father's /Mother's sign \_\_\_\_\_

Date: 1<sup>st</sup> December, 2020

Day : Tuesday

. Circle the correct option.

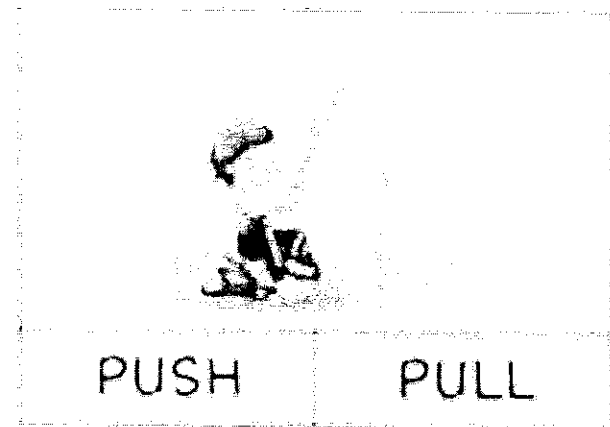
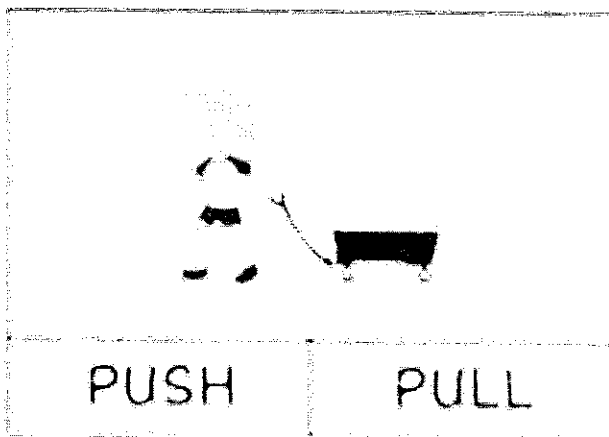
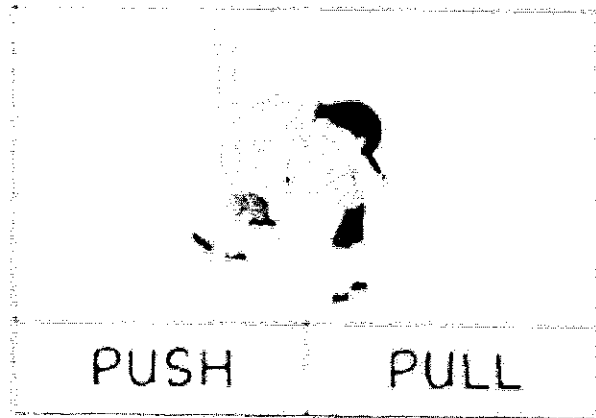
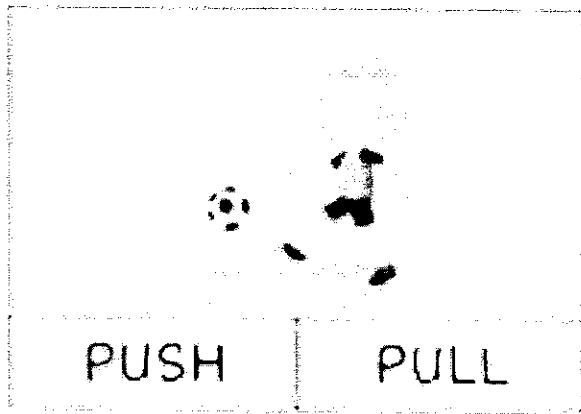
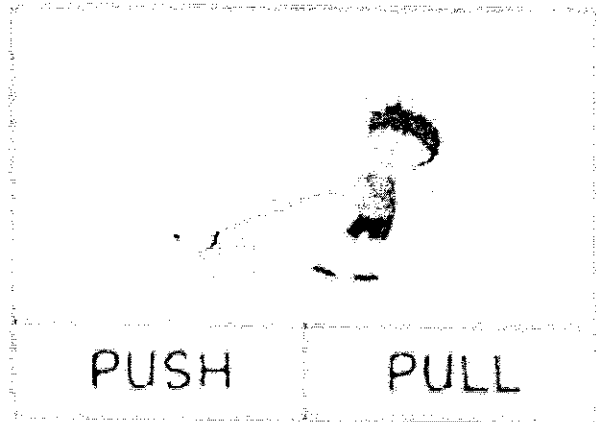
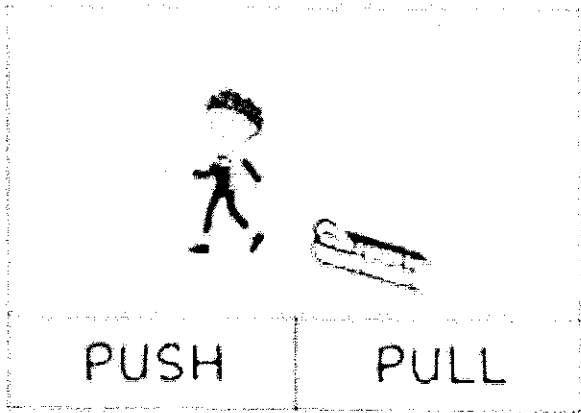

Father's /Mother's sign \_\_\_\_\_

Date: 2nd December, 2020

Day : Wednesday

- . Use red color the air transport
- . Use green color the land transport
- . Use blue color the water transport

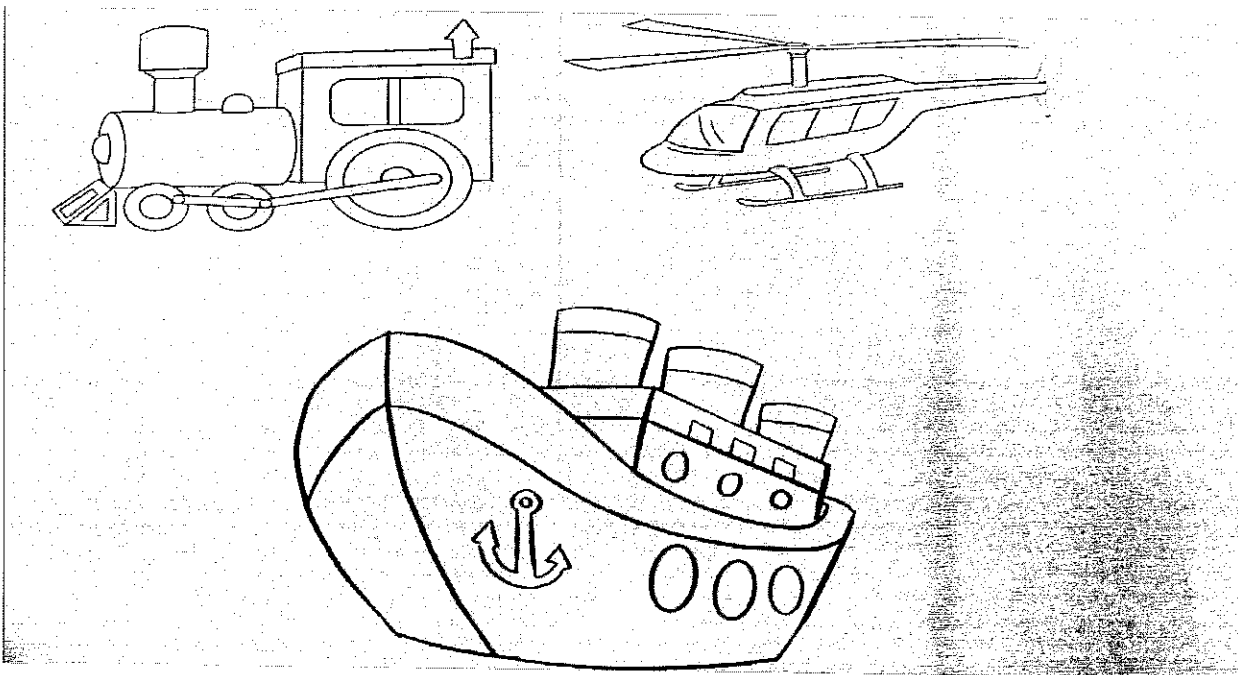
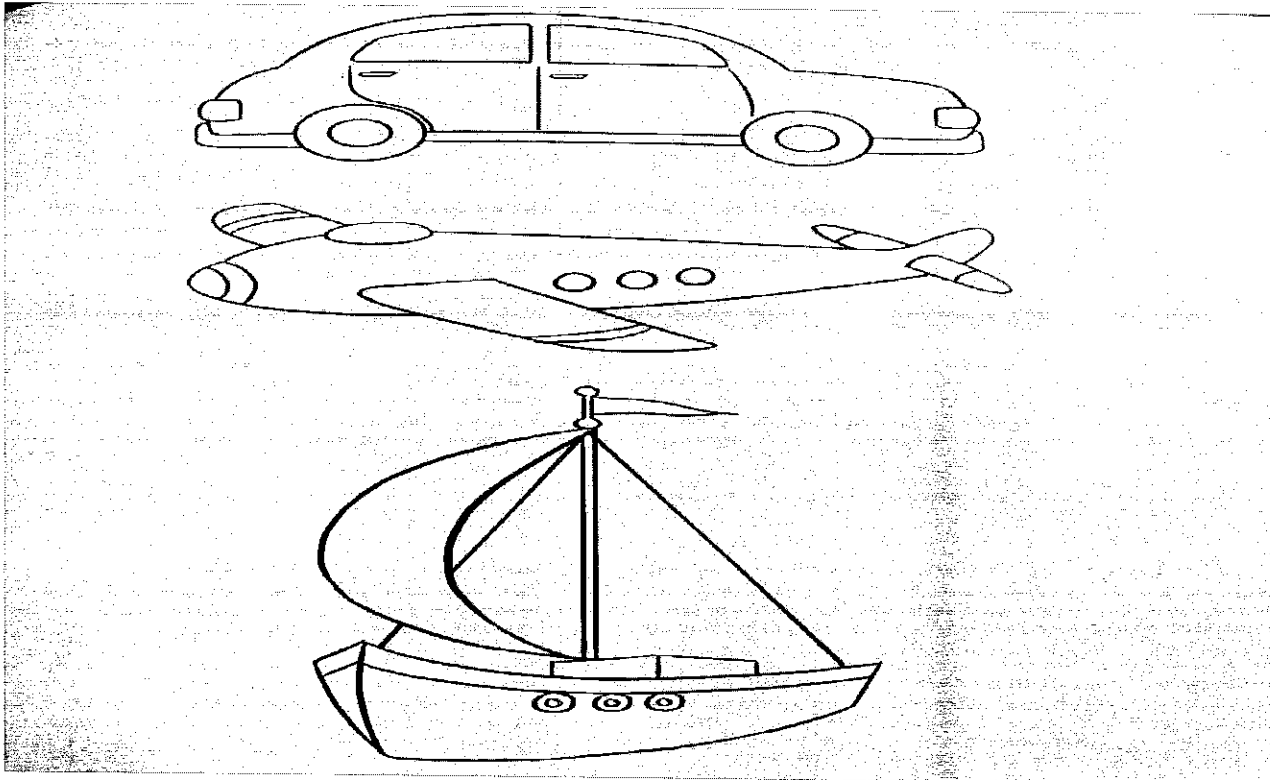

Father's /Mother's sign \_\_\_\_\_

Date: 3<sup>rd</sup> December, 2020

Day: Thursday

. Write the Correct word air , land , water transport

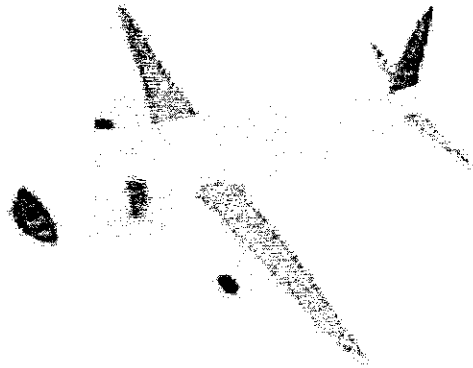
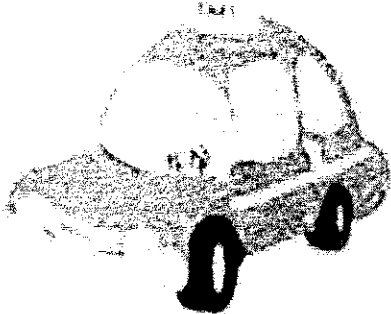
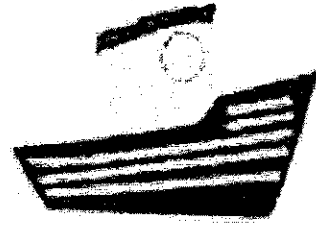
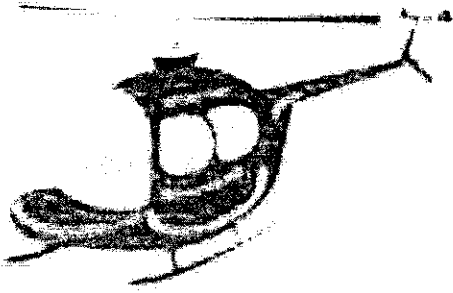

Father's /Mother's sign \_\_\_\_\_

Date: 4<sup>th</sup> December, 2020

Day : Friday

Draw the correct in picture each box.

Water	Air	Land

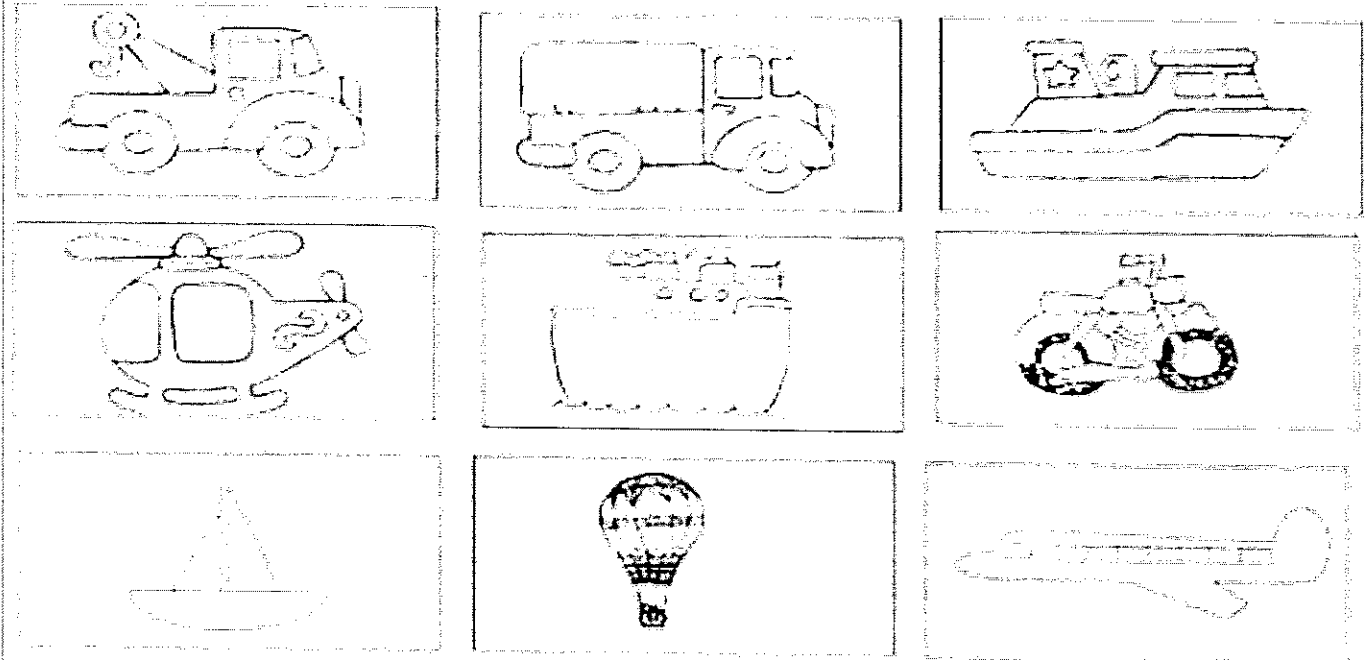

Father's /Mother's sign \_\_\_\_\_

Date: 5<sup>th</sup> December, 2020

Day : Saturday

. Write the answer yes or not.

Q.1 Do you have a moving machine at home

---

---

---

Q.2 Do you have a bicycle or scooter

---

---

---

Q . 3 Do you like air transport

---

---

---

Q . 4 Do you like land transport

---

---

---

Q . 5 Do you like water transport

---

---

---

Father's /Mother's sign \_\_\_\_\_

Date: 7<sup>th</sup> December, 2020

Day : Monday

# Unit : 7 Heat and Light

. Draw lines to match the items with either heat or light .

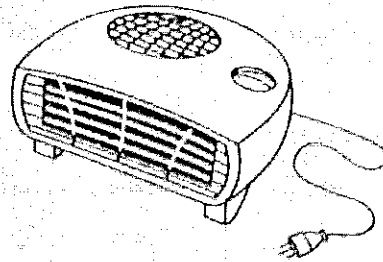
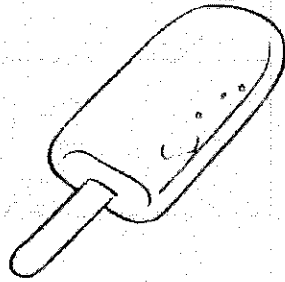

Heat

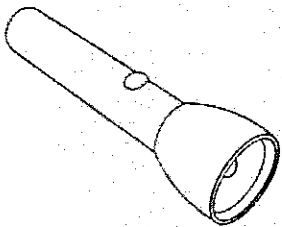
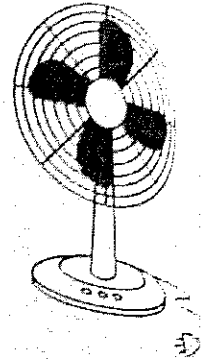

Light

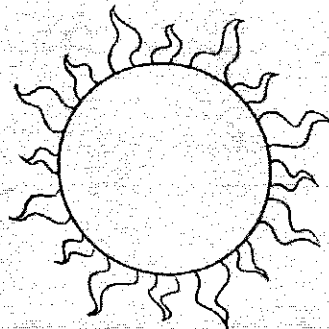
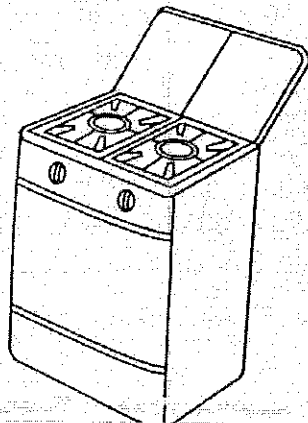
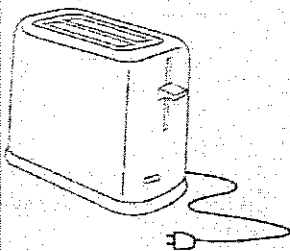
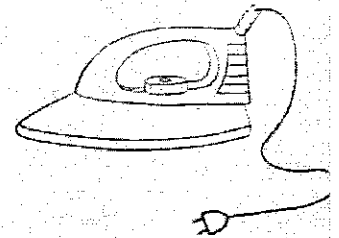

Father's /Mother's sign \_\_\_\_\_

Date: 8<sup>th</sup> December, 2020

Day : Tuesday

. Circle the objects that give us heat and light.

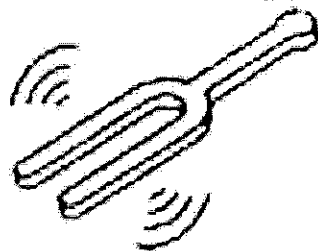
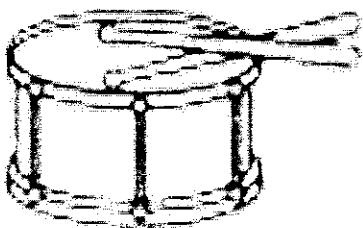
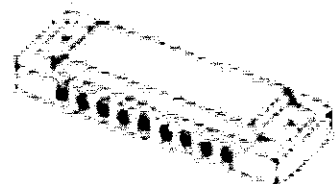
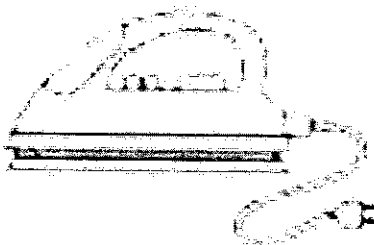
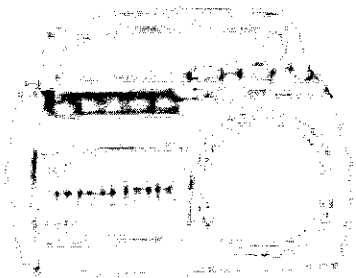
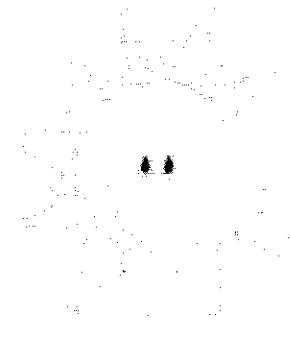
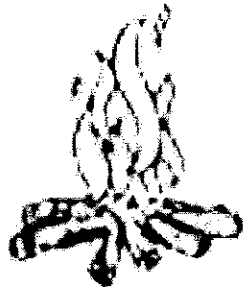
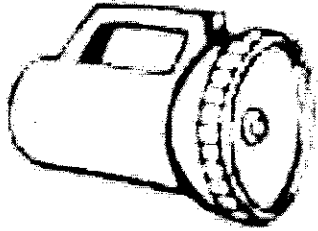

Father's /Mother's sign \_\_\_\_\_



Date: 9<sup>th</sup> December, 2020

Day : Wednesday

. Look and draw the pictures in each box.

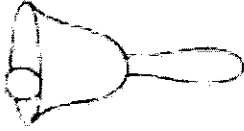
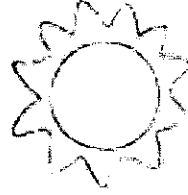
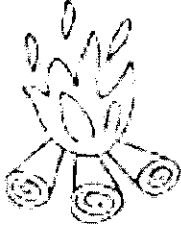

Heat

Light

Sound





Father's /Mother's sign \_\_\_\_\_

Date: 10<sup>th</sup> December, 2020

Day : Thursday

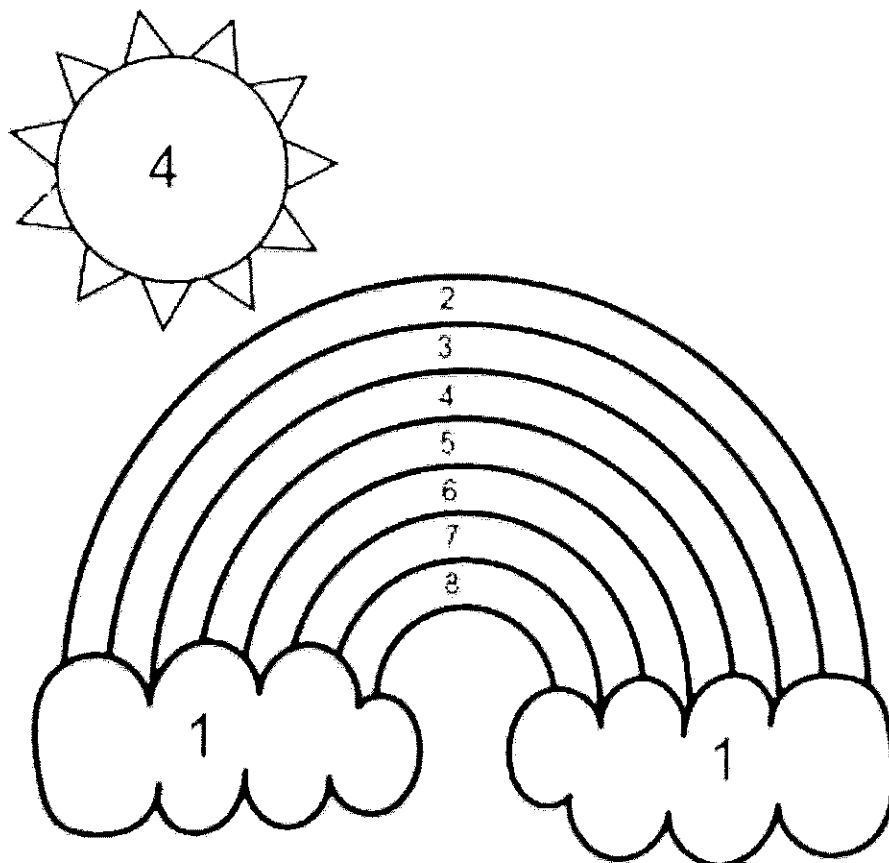
# . Color the rain bow



- |           |           |
|-----------|-----------|
| 1- white  | 5- green  |
| 2- red    | 6- blue   |
| 3- orange | 7- indigo |
| 4- yellow | 8- violet |

Father's /Mother's sign \_\_\_\_\_

. Write the answer yes or not.

Q.1 Can you touch rain bow

---

---

---

Q.2 Can you see rain bow

---

---

---

Q . 3 How many color in rain bow

---

---

---

Q . 4 Sun give us heat ?

---

---

---

Father's /Mother's sign \_\_\_\_\_

Unit : 8 Sounds

. Circle the objects that you can hear .

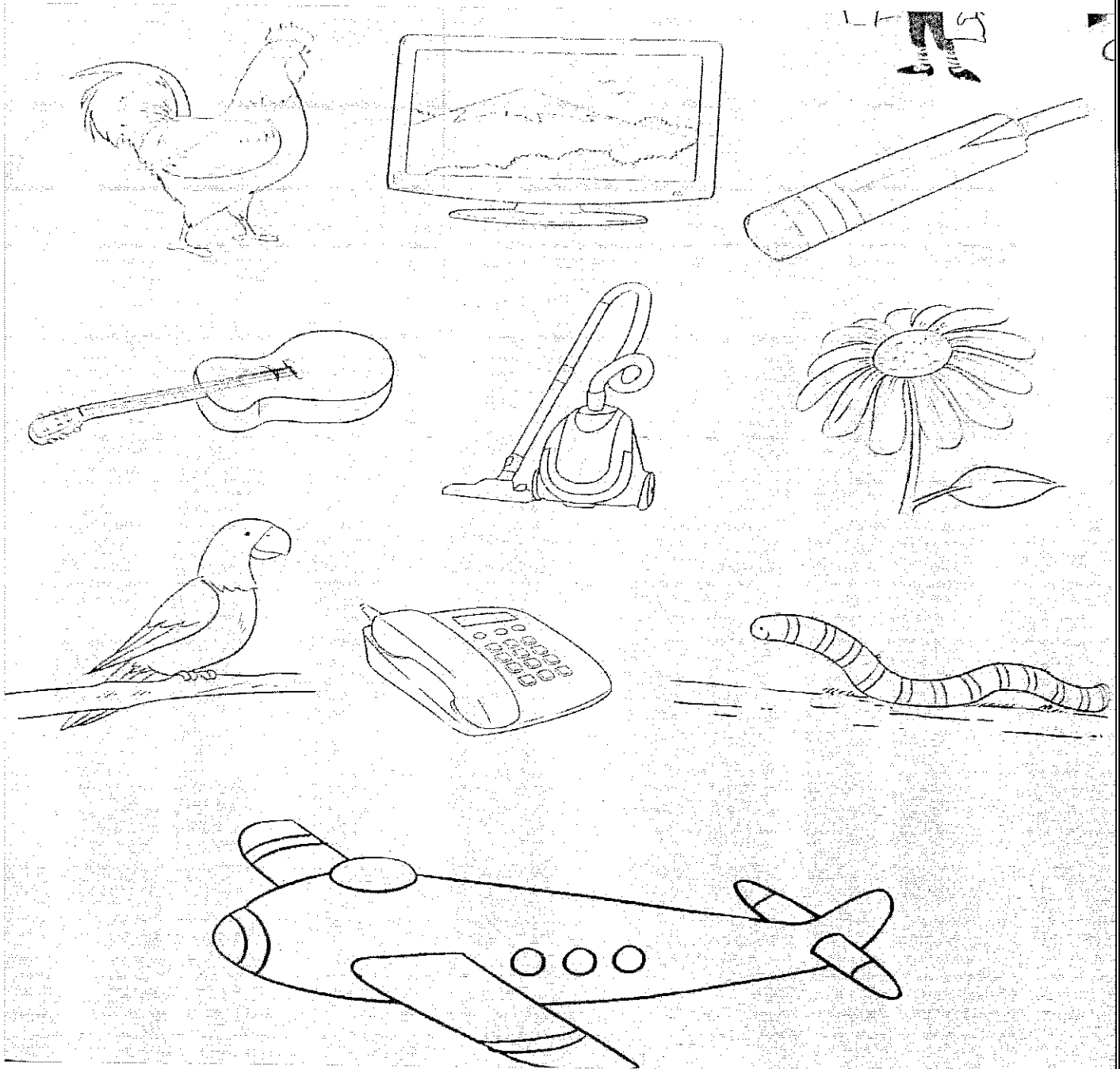

Father's /Mother's sign \_\_\_\_\_

Date: 14<sup>th</sup> December, 2020

Day : Monday

. Color the objects that you can hear

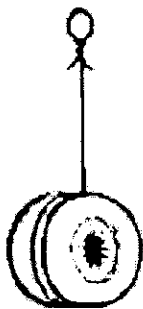
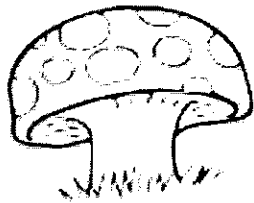
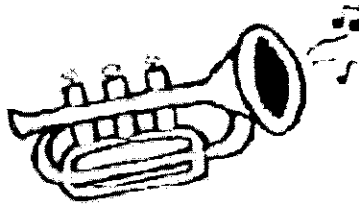
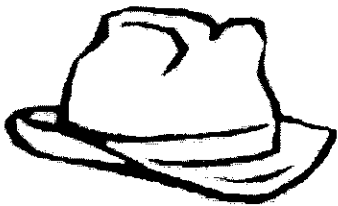
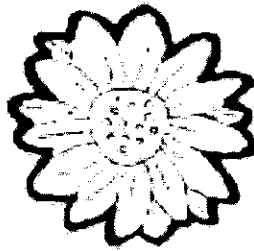
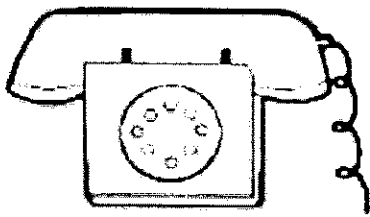

Father's /Mother's sign \_\_\_\_\_

Date: 15<sup>th</sup> December, 2020

Day : Tuesday

Unit : 9 The Solar System

. Color the sun and planets.

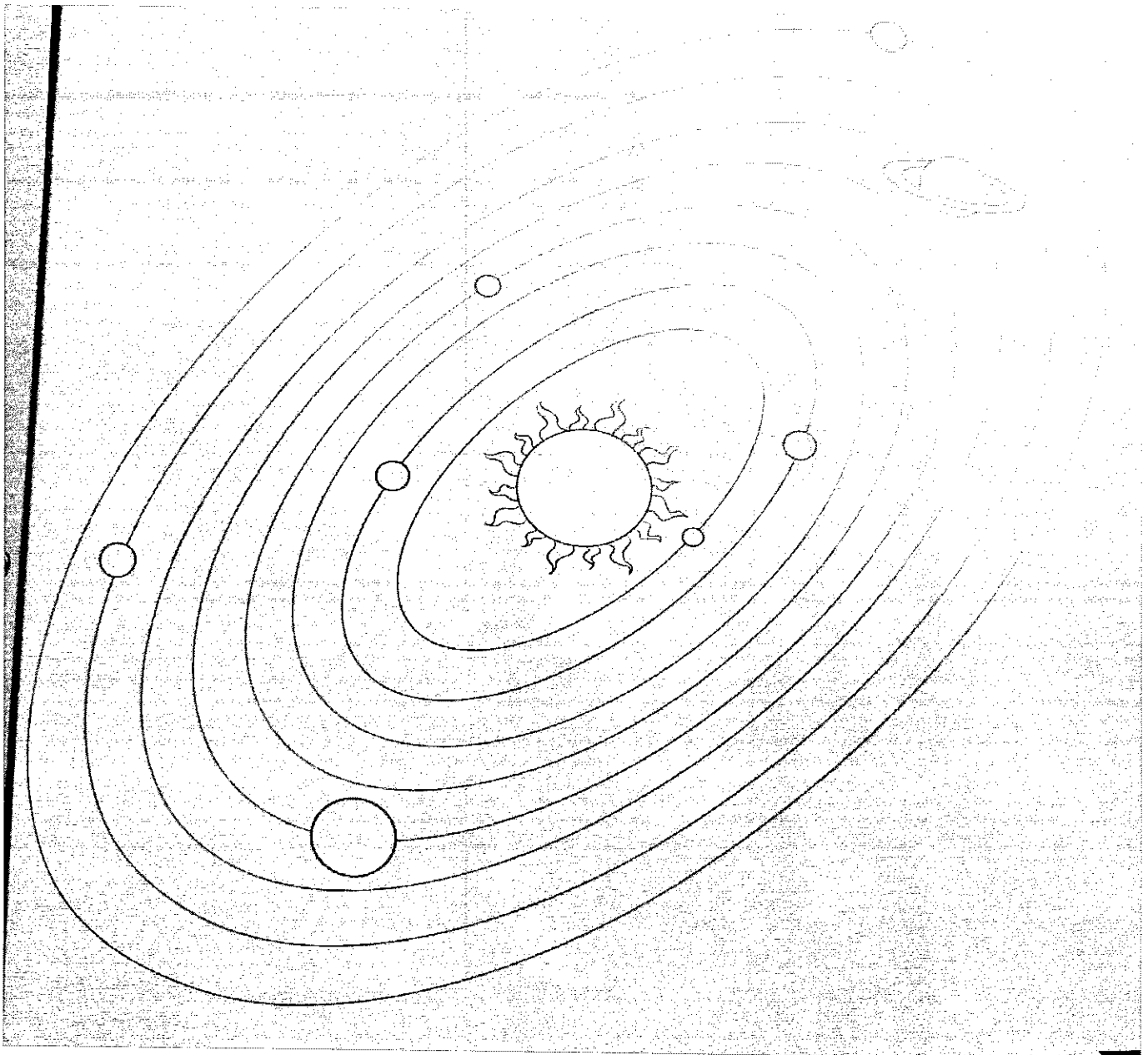

Father's /Mother's sign \_\_\_\_\_

Date: 16<sup>th</sup> December, 2020

Day: Wednesday

# . Color the sun and planets.

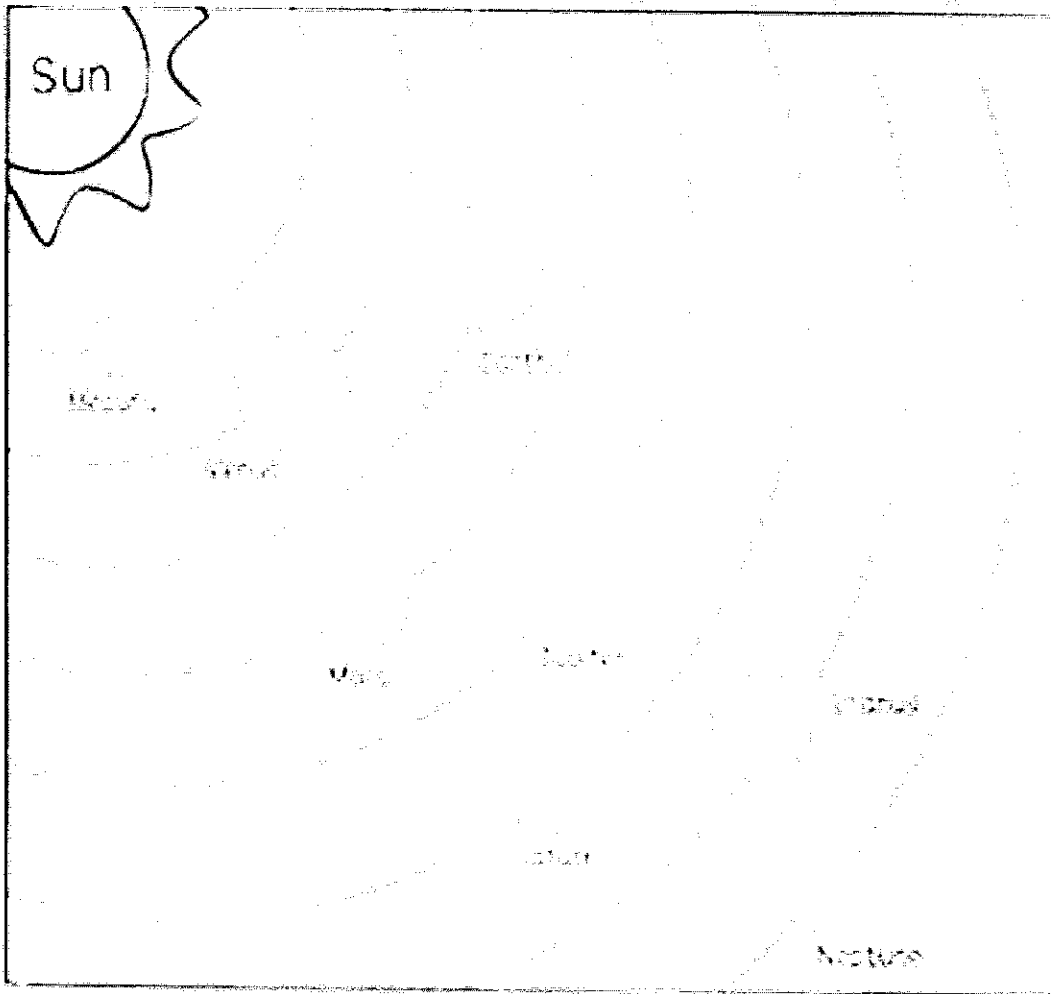

www.civildatas.com

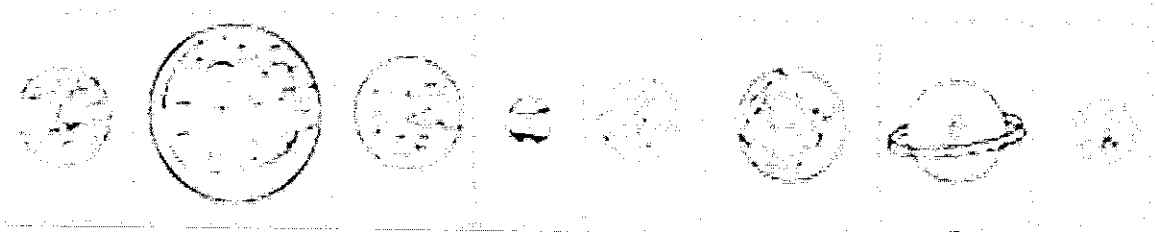

Father's /Mother's sign \_\_\_\_\_

Date: 17<sup>th</sup> December, 2020

Day : Thursday

# . Color the starry night.

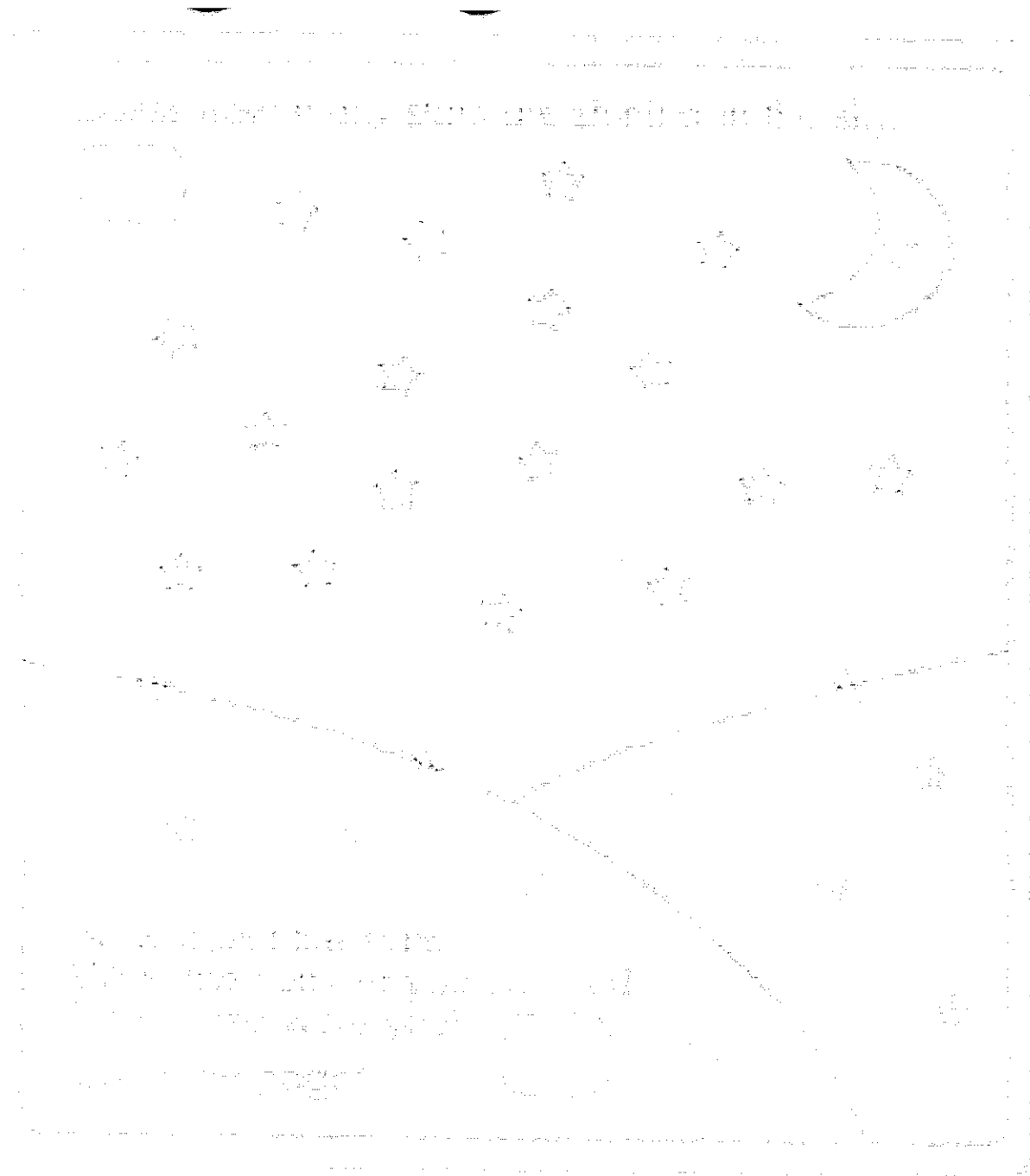

Father's /Mother's sign \_\_\_\_\_



Date: 18<sup>th</sup> December, 2020

Day : Friday

. Write the answer yes or not.

Q.1 How many planets in our earth ?

Ans . Eight

---

---

---

Q.2 What does the Earth travel around?

Ans . sun

---

---

---

Q . 3 Is the sun a planet or a star ?

Ans . star

---

---

---

Q . 4 The Earth is Planet or star?

Ans . planet

---

---

---

Father's /Mother's sign \_\_\_\_\_

Date: 19<sup>th</sup> December, 2020

Day : Saturday

Topic : Rocket launch

. Trace and color the rocket.

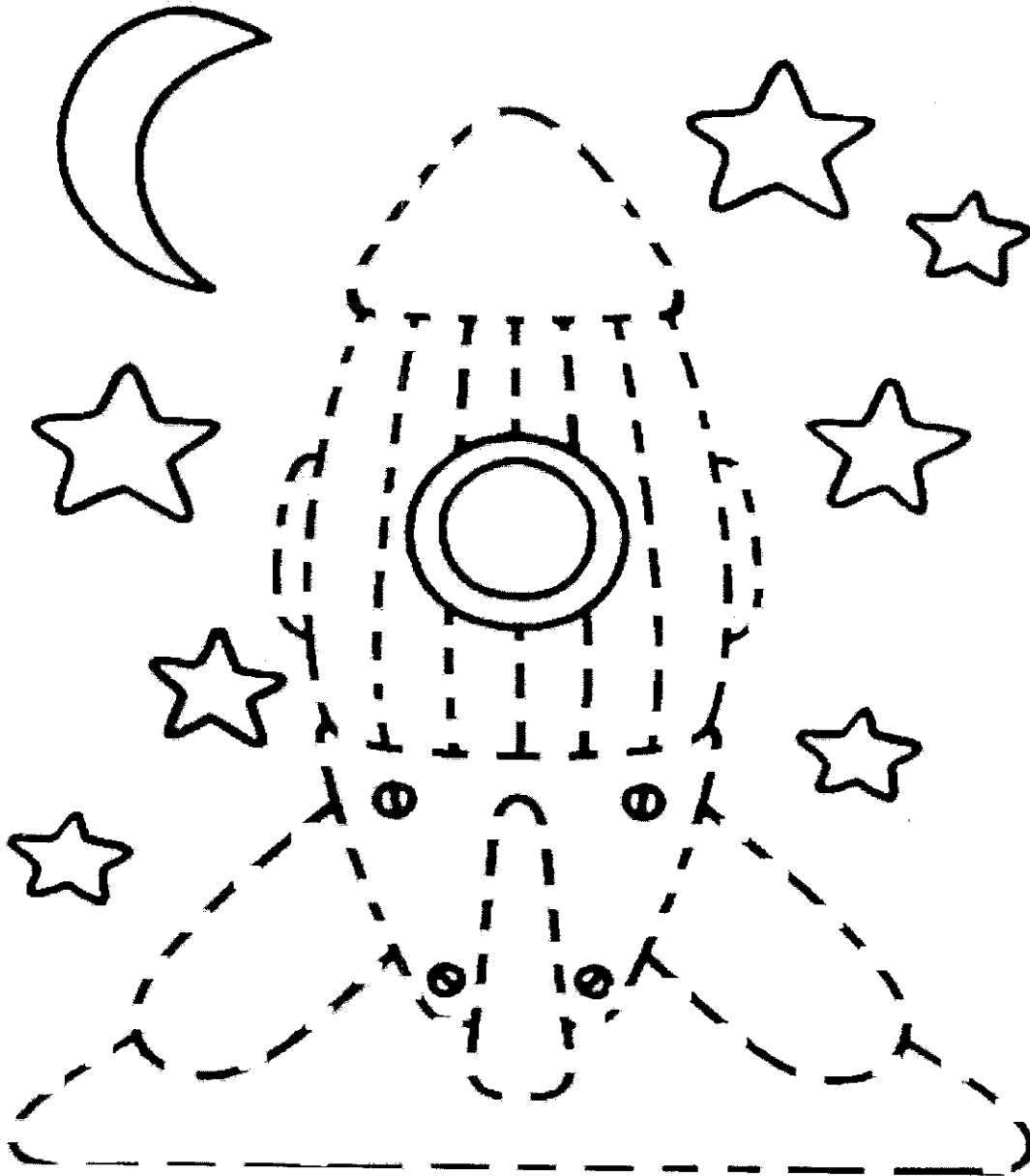

Father's /Mother's sign \_\_\_\_\_

تخلیقی لکھائی

میرا تعارف

بہن / بھائی

نام

سکول

جماعت

1: میرا نام \_\_\_\_\_ ہے

2: میرے سکول کا نام ڈی پی ایس ہے۔

3: میں جماعت پریپ میں پڑھتا / پڑھتی ہوں۔

4: میرے \_\_\_\_\_ بہن بھائی ہیں۔

1:

2:

3:

4:

تاریخ: 23- دسمبر 2020

دن: بدھ

الفاظ / جملے

جملے

الفاظ

روٹی:

---

ٹافی:

---

موتی:

---

گاڑی:

---

سوتی:

---

دن: منگل

تاریخ: 22- دسمبر 2020

پرنندوں کے نام

_____	_____	_____	کوٹا
_____	_____	_____	کبوتر
_____	_____	_____	چڑیا
_____	_____	_____	طوطا
_____	_____	_____	مور

تخلیقی لکھائی

میرا تعارف

بہن/بھائی

نام

سکول

جماعت

1: میرا نام \_\_\_\_\_ ہے

2: میرے سکول کا نام ڈی پی ایس ہے۔

3: میں جماعت پریپ میں پڑھتا/پڑھتی ہوں۔

4: میرے \_\_\_\_\_ بہن/بھائی ہیں۔

1:

2:

3:

4:

پرنندوں کے نام

_____	_____	_____	کوا
_____	_____	_____	کبوتر
_____	_____	_____	چڑیا
_____	_____	_____	طوطا
_____	_____	_____	مور

الفاظ / جملے

جملے

الفاظ

روٹی:

---

ٹافی:

---

موتی:

---

گاڑی:

---

سوتی:

---





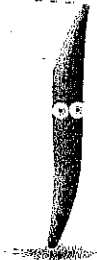
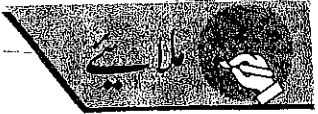

ع

ع

ع

ع

ع

ف

ک

س

م

ن

ہ

تلاش کیے



بے

بی

بو

با

ب

ج

د

ز

س

ص

ط

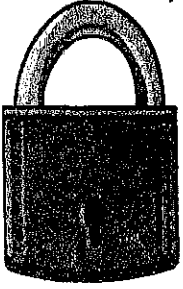

تالے

تالے

یہ دو تالے ہیں۔



دانے

دانے

ڈالے۔ دانے نے امی

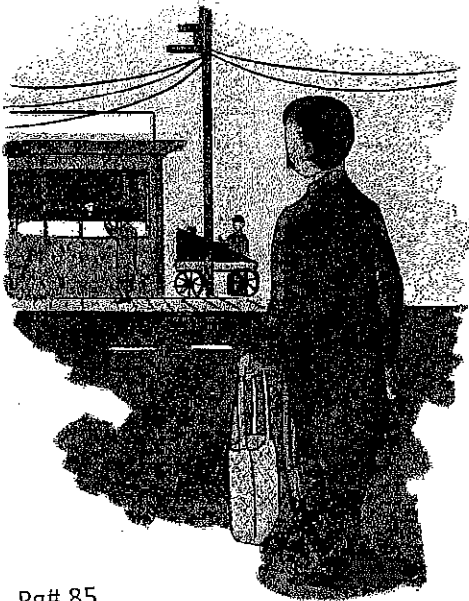

جاتے

جاتے

بازار ابو ہیں۔ جاتے



تارے

تا رے

بابجے

با جے

سارے

سا رے

کالے

کا لے

روتے

رو تے

کونے

کو نے

لوہے

لو ہے



امی

یہ کون ہیں؟ یہ امی ہیں۔



ابو

یہ کون ہیں؟



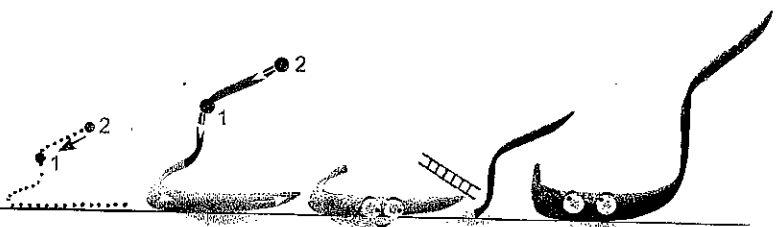
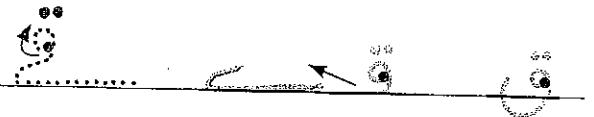
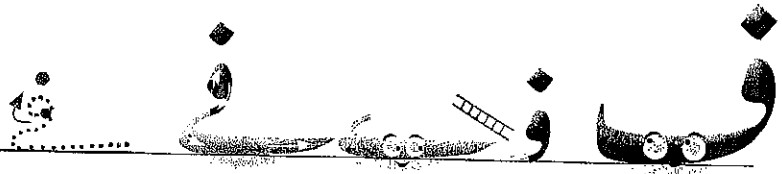
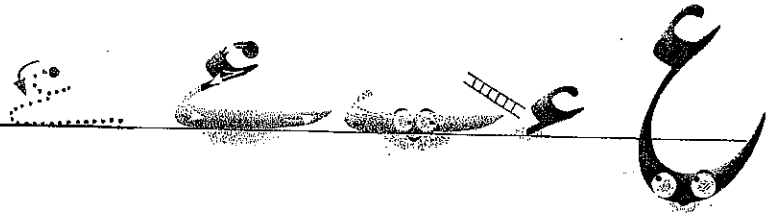
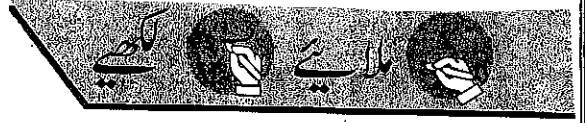

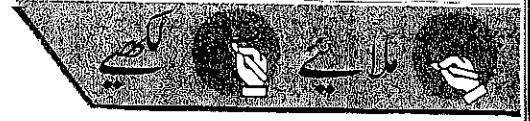

س س س س س

ش ش ش ش ش

ص ص ص ص ص

ض ض ض ض ض

ط ط ط ط ط

ظ ظ ظ ظ ظ



ہم سب تہرا تہی ہیں

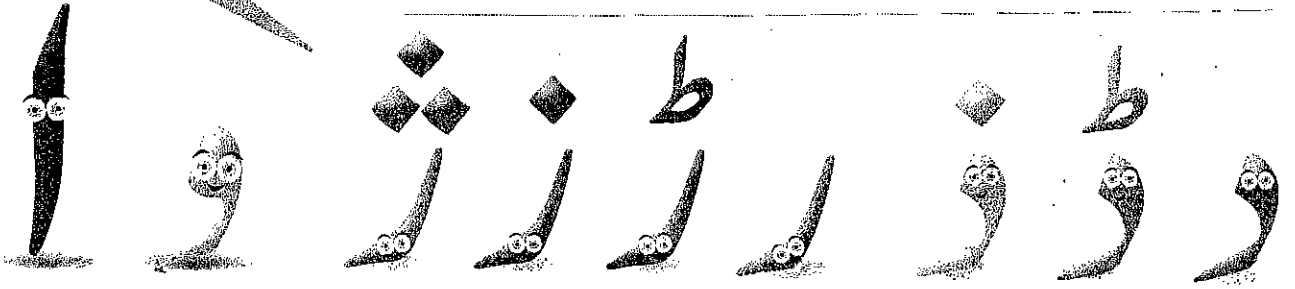



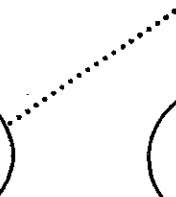
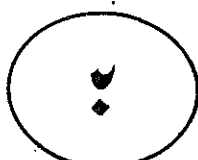
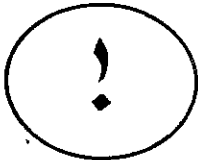
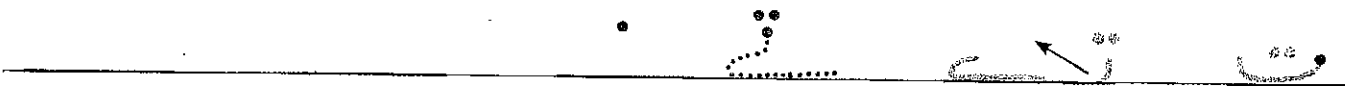
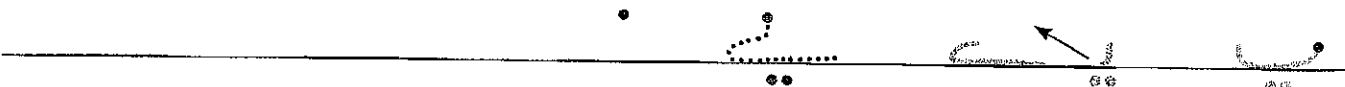
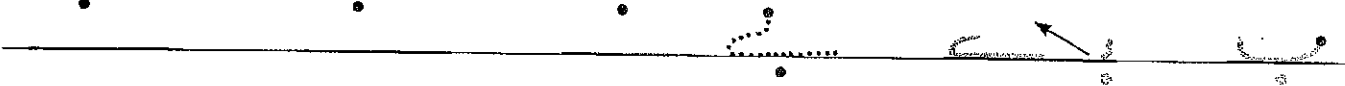
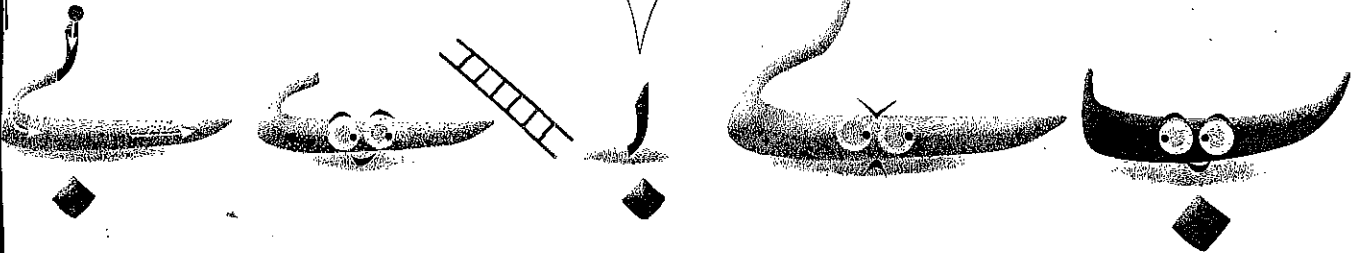
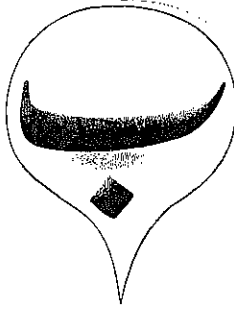
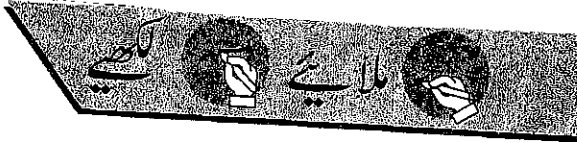

\_\_\_\_\_

چابی

چا بی

\_\_\_\_\_

پانی

پا نی

\_\_\_\_\_

تالی

تا لی

\_\_\_\_\_

گاڑی

گا رے

\_\_\_\_\_

موتی

مو تی

\_\_\_\_\_

ٹوپی

ٹو پی

\_\_\_\_\_

بوری

بو ری

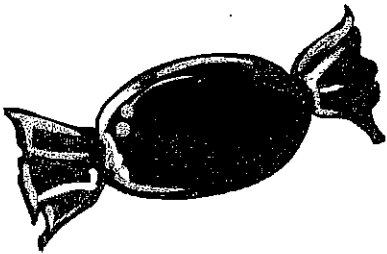

ٹافی

ٹا فی

لال ٹافی ہے۔ اور یہ کالی

لفظ بنائیے

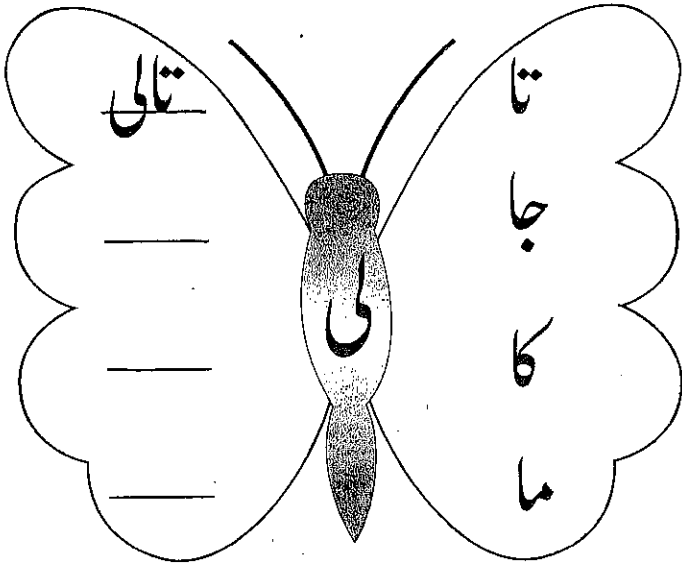
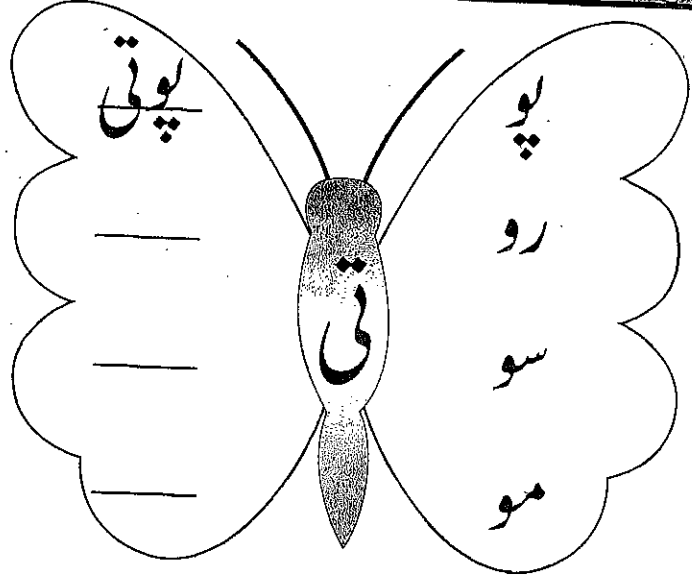

کھجے پڑھے لکھے

ناک ناک چار چار مور مار





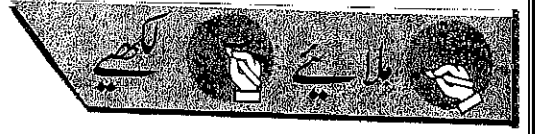

س س س س س س س س س س

ش ش ش ش ش ش ش ش ش ش

ص ص ص ص ص ص ص ص ص ص

ض ض ض ض ض ض ض ض ض ض

ظ ظ ظ ظ ظ ظ ظ ظ ظ ظ

ظ ظ ظ ظ ظ ظ ظ ظ ظ ظ



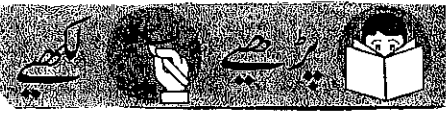

ہم سب شرارتی ہیں

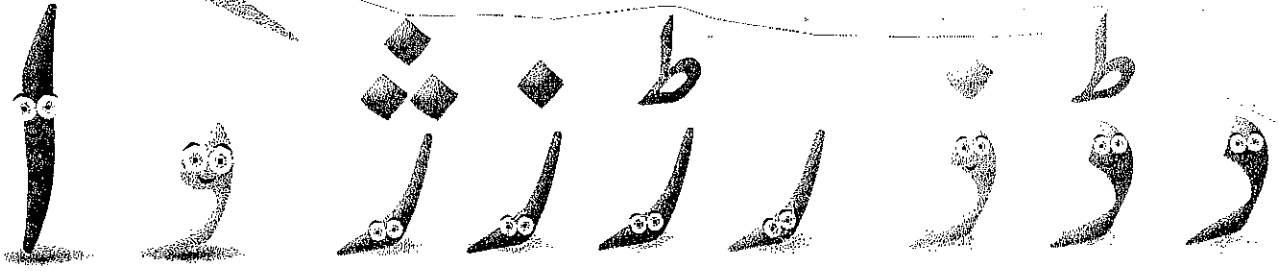

				Alif
				Zay
				Dal
				Ra
				Za
				Re
				Ze
				Ri



ج

جی

جی

ج

جی

ج جی جی

چ چ جی

ح ح جی

خ خ جی

خ

ح

ج

چ

ا

ج

چ

خ

ب

ج

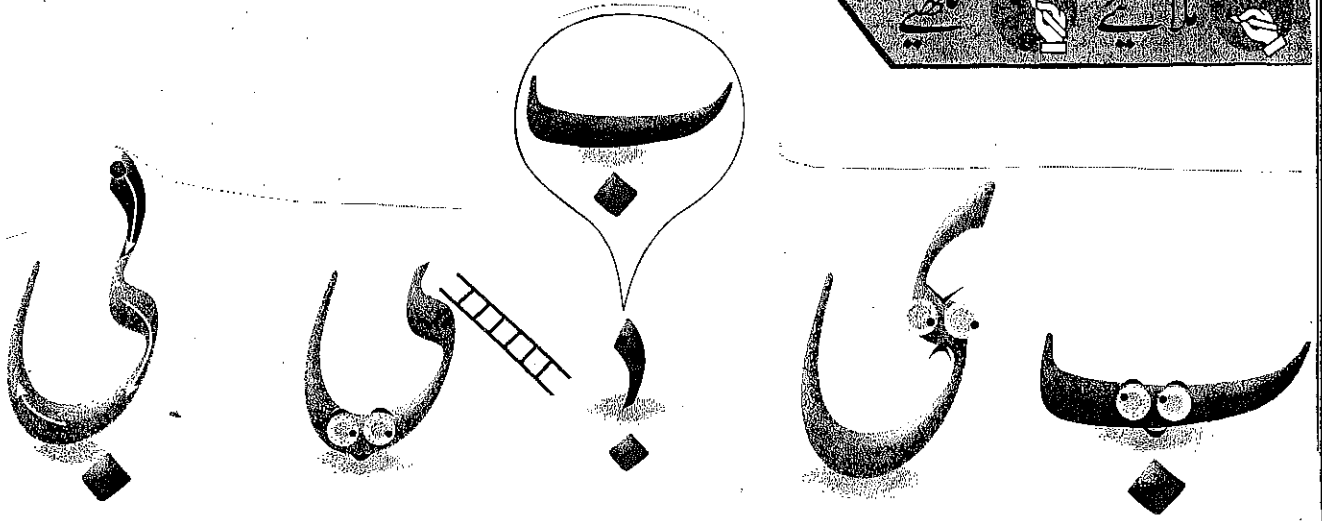

پ پ پ

پ پ پ

پ پ پ

پ پ پ

پ پ پ

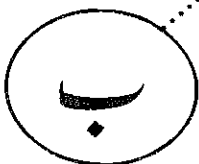
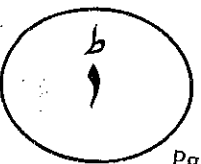
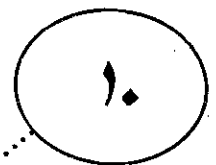
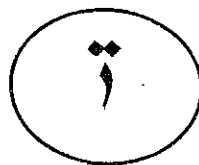
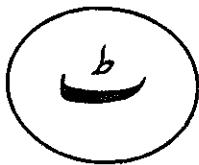

# ڈسٹرکٹ پبلک سکول اینڈ کالج دیپال پور۔

تعطیلات موسم سرما کا کام / دوسری میعاد

سیشن ۲۰۲۰ء تا ۲۰۲۱ء

اردو جماعت: پریپ

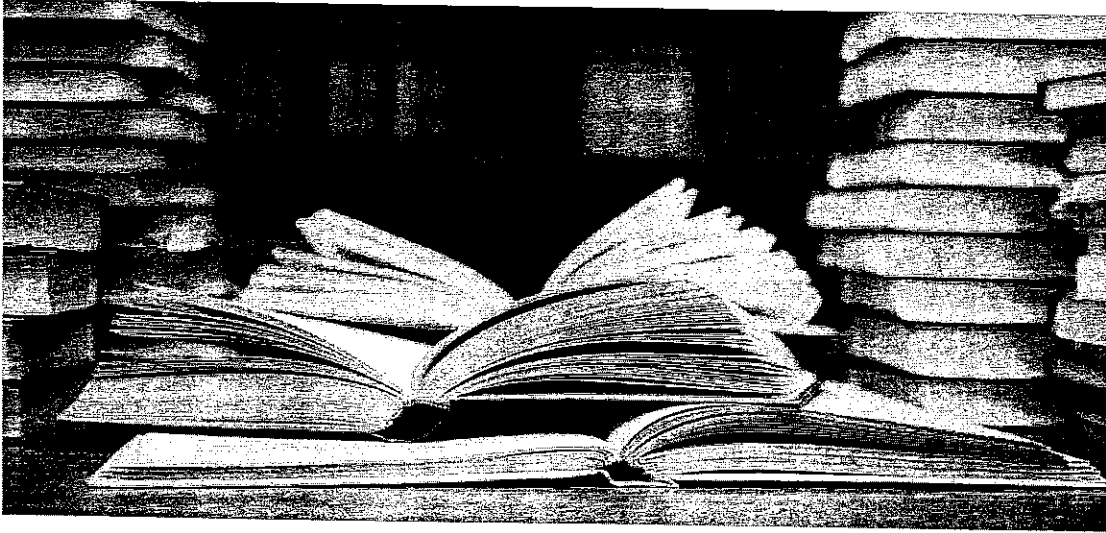

نام طالب علم / طالبہ: .....

سیکشن: .....

رول نمبر: .....